

# Operating Instructions

Version 3.0

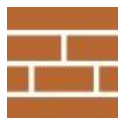

## HYDROMETTE BL COMPACT RH-T 165



EN



**GANN MESS- U. REGELTECHNIK GMBH**

70839 GERLINGEN

SCHILLERSTRASSE 63

INTERNET: <http://www.gann.de>

Verkauf National: TELEFON 07156-4907-0  
Verkauf International TELEFON +49 7156-4907-0

TELEFAX 07156-4907-40  
TELEFAX +49 7156-4907-48

EMAIL [verkauf@gann.de](mailto:verkauf@gann.de)  
EMAIL [sales@gann.de](mailto:sales@gann.de)

## Disclaimer

GANN Mess- u. Regeltechnik GmbH does not make any assurances or warranties with respect to this document and, to the extent permitted by law, limits its liability for breach of any implied warranty to the replacement of this document with another. Furthermore, GANN Mess- u. Regeltechnik GmbH reserves the right to revise this publication at any time without having to notify anyone about such revisions.

The information provided in this documentation includes general descriptions and/or technical characteristics for the performance of the equipment described herein. This documentation cannot be used as a proper assessment of the suitability or reliability of the equipment for a specific application by a user and must not be used as a substitute for such an assessment. It is the responsibility of any such user to carry out an appropriate and complete risk assessment, evaluation and testing of the equipment with regard to his specific application. Neither GANN Mess- u. Regeltechnik GmbH nor any of its partner or subsidiary companies can be made responsible or liable in the event of misuse of the information contained in this document.

All relevant national, regional and local safety regulations must always be observed when installing and using this device. For reasons of safety and to ensure compliance with the documented system data, only the manufacturer is authorised to carry out repairs to components. Failure to observe this information may result in injury or damage to the equipment.

Copyright © 2024 GANN Mess- u. Regeltechnik GmbH, Gerlingen

All rights reserved. No part of this publication may be reproduced, processed or distributed in any form, including photocopying, recording or any other electronic or mechanical process, without the written permission of the publisher. Requests for permissions must be made in writing to the publisher at the address given on the title page.



## Table of Contents

1	Foreword .....	5
1.1	User Description .....	5
1.2	Intended Use .....	5
1.3	Non-Intended Use .....	5
1.4	Explanation of the General Warnings .....	6
1.5	General Safety Instructions .....	7
1.5.1	Persons at Risk.....	7
1.5.2	Preparation and Start-up.....	8
1.5.3	Use / Operation .....	8
1.5.4	Care, Maintenance and Inspection .....	9
1.5.5	Troubleshooting .....	9
1.5.6	Disposal .....	9
2	Specifications.....	10
2.1	Technical Data .....	10
2.2	Prohibited Environmental Conditions .....	10
2.3	Transport- & Storage Conditions.....	11
2.4	Measuring Range.....	11
3	General Information.....	12
3.1	Standards and Directives.....	12
3.2	Warranty.....	12
4	Description of the Product .....	13
5	Device Layout and Button Assignment .....	14
5.1	Display Symbols.....	15
5.1.1	Main Menu Symbols.....	15
5.1.2	Other Symbols .....	15
5.2	Switching the Device On and Off.....	16
5.3	Setting Menus.....	16
5.3.1	Measuring Menu (Main Menu) .....	17
5.3.2	Measuring Mode Selection .....	17
5.3.3	Maximum Value Display .....	22
5.3.4	Minimum Value Display.....	23
5.3.5	Memory Menu.....	24
6	Other Functions.....	25
6.1	Automatic Switch-Off .....	25

6.2	Battery Monitoring.....	25
6.3	Querying the Device Firmware.....	25
7	Installation of the PC-Software GANN Dialog Pro.....	26
8	USB-Communication with a PC.....	28
9	Application Notes.....	29
9.1	General Notes on Humidity / Air Temperature Measurement.....	29
9.2	Using the Hydromette BL Compact RH-T.....	30
9.2.1	Precautions.....	31
9.3	Measuring Relative Humidity.....	31
9.4	Equilibrium Wood Moisture Content (EMC).....	32
9.5	Water Activity (Aw).....	32
9.6	Measuring Air Temperature.....	32
9.7	Dew Point Temperature.....	33
9.8	Enthalpy.....	33
9.9	Wet-Bulb Thermometer.....	34
9.10	Measuring the relative Air Humidity in Building Materials.....	35
9.10.1	"Drill hole" Method.....	36
10	Accessories.....	37
11	Appendix.....	38
11.1	Material-Table.....	38
11.2	Wood Moisture Equilibrium.....	38
11.3	Dew Point Table.....	39
11.4	Equilibrium Moisture Values in Percent by Weight.....	40
11.5	Comparison Graph of Humidity – Material Moisture Content.....	41
11.6	References.....	42
11.7	General Concluding Remarks.....	42
12	EU Declaration of Conformity.....	43

# 1 Foreword

## 1.1 User Description

These instructions are intended for the end user of the product. The end user of the product is a person who has read and understood these operating instructions, is an experienced user of similar devices and is aware of all possible dangers and can act accordingly.

The device may only be used by persons aged 14 and over who have read and understood these operating instructions, are familiar with the operation of similar products and are aware of all possible dangers and act accordingly.

The device is intended for use by persons who have experience with moisture measurements (structural moisture, wood moisture, climate, etc.).

All personnel involved in the operation, installation, inspection and maintenance of the product must be qualified to carry out the associated work. If the personnel concerned do not already have the required knowledge and skills, appropriate training and instruction must be ensured.

All local regulations must be observed.

## 1.2 Intended Use

The Hydromette BL Compact RH-T is a precise thermo-hygrometer for quick measurement of relative humidity and air temperature. It can be used to measure in bulk materials, air ducts and solids (e.g. masonry, concrete, etc.).

The Hydromette BL Compact RH-T may only be used for air humidity and air temperature measurements as well as air humidity and air temperature measurements in solids (NOT in liquids).

## 1.3 Non-Intended Use





The device is not intended for any applications that are not listed in these operating instructions.

The device, accessories, tools, software, etc. must be used in accordance with these instructions, taking into account the working conditions and the work to be performed. Using the product for work other than that for which it is intended will result in a hazardous situation.

The device may only be used together with the original accessories. The device must only be used within the specified performance limits as described in these instructions.

## 1.4 Explanation of the General Warnings

The following danger levels are used in this operating manual to indicate potentially dangerous situations and important safety instructions:

Danger Level	Description
 <b>DANGER</b>	Danger / Indicates a hazardous situation which, if not avoided, will result in death or serious irreversible injuries.
 <b>WARNING</b>	Warning / Indicates a hazardous situation which, if not avoided, could result in death or serious irreversible injuries.
 <b>CAUTION</b>	Caution / Indicates a hazardous situation which, if not avoided, could result in minor or moderate injuries.
 <b>INFORMATION</b>	Indicates important information.

## 1.5 General Safety Instructions

It must be ensured that the complete instructions and all safety instructions have been read and understood before using this device.

All instructions must be followed. This prevents accidents that can result in property damage or minor or moderate injuries.



All safety information and instructions must be kept for future reference and passed on to subsequent users of the product.

### INFORMATION

The manufacturer shall not be liable for any damage to property or injuries to persons that can be attributed to incorrect handling or non-compliance with the safety instructions. In such cases, the warranty shall be void.

### 1.5.1 Persons at Risk

Persons with reduced physical, sensory or mental capabilities or lack of experience and knowledge must be supervised or instructed in the safe use of the device and understand the associated hazards.

Children must be supervised to ensure that they do not play with the device. The device is not a toy. There is a risk of swallowing small parts of the device (e.g. battery compartment cover) or an accessory (e.g. TF-Stick, not for all BL device types).

This device is not intended for use by persons with reduced physical, sensory or intellectual capabilities, or lack of experience and/or knowledge.



**WARNING**

Risk of suffocation, injury or permanent disability. The device must not be used by persons under the age of 14.

Risk of suffocation! Keep packaging away from children.

### 1.5.2 Preparation and Start-up

Never store or place the device in a location where it can fall or be drawn into water or other liquids.

To avoid the risk of electric shock, never immerse the device in water or other liquids.

Always remove all packaging before operating the device.



**WARNING**

Fire hazard!  
Do not use a damaged device.

In the event of visible damage, strong odours or excessive heating of components, the battery must be removed immediately and the appliance must not continue to be used.

### 1.5.3 Use / Operation



**CAUTION**

Risk of damage. The device is a highly sensitive measuring instrument.  
Only use the device in a controlled electromagnetic environment.

Do not let the device drop onto hard surfaces. This can result in malfunctions or functional failures. Normal use of the device, without excluding hazards to the user, cannot be guaranteed.

The device is fragile.

To avoid overheating, the device must not be covered or used near heat sources or direct sunlight and only be used at ambient temperatures between 0 °C and 40 °C.

The device may not be stored or operated in aggressive atmospheres or atmospheres containing solvents!

The measuring device may be operated in residential and commercial areas.

Measurements **must not** be carried out on conductive surfaces.



#### 1.5.4 Care, Maintenance and Inspection



**CAUTION**

Remove the battery before cleaning the product. Do not use abrasive cleaning cloths or chemicals to clean the product as these can damage the surface.

Stop using the product in the case of visible damage, strong odours development or excessive overheating of components.

Only use original accessories.

Changes to the device and technical modifications are not permitted without the written consent of the manufacturer.

All connection options and the device itself must not be sprayed directly or indirectly with water when cleaning (connections depend on the device! e.g. BNC-, 2.5 mm, 3.5 mm jack receptacle and mini-USB port).

Our recommendation: To ensure functionality, have all your measuring equipment checked by the manufacturer every 2–3 years (depending on the frequency of use).

#### 1.5.5 Troubleshooting

Do not repair the device yourself. Contact the manufacturer if the device is not functioning properly.

#### 1.5.6 Disposal

Electrical equipment, accessories and packaging must not be disposed of together with household waste (only for EU countries) and must be disposed of in compliance with the European Directive 2012/19/EU on waste electrical and electronic equipment and its implementation in accordance with national law. Electrical equipment that has reached the end of its service life must be collected separately and sent to an environmentally compatible recycling facility.

The WEEE symbol draws attention to the need for disposal.

The device contains a battery. Batteries must not be disposed of with normal household waste. They may contain toxic heavy metals and are subject to the hazardous waste ordinance. For this reason, dispose of the battery at a local collection point for the recycling of waste electrical and electronic equipment. Caution, there is a risk of explosion if the wrong type of battery is inserted. Handle used batteries according to the manufacturer's instructions.

**Gann Mess- u. Regeltechnik GmbH accepts no liability for damage caused by non-compliance with the operating instructions or by violation of a duty to care during transport, storage or operation of the instrument, even if this duty to care is not specifically discussed in the operating instructions.**

## 2 Specifications

### 2.1 Technical Data

#### Hydromette

Display:	LCD segment display with three lines
Display resolution:	0.1 % for humidity 0.1 °C for temperature
Response time:	< 2 s
Storage conditions:	+ 5 to + 40 °C - 10 to + 60 °C (for a short time)
Operating conditions:	0 to + 50 °C - 10 to + 60 °C (for a short time) < 85 % R.H. non-condensing
Power supply:	9-V-block battery
Types that can be used:	Types 6LR61 and Type 6F22
Dimensions:	
Model 165	355 x 50 x 30 (L x W x H) mm (incl. Sensor pipe Ø 5.5mm)
Weight:	
Model 165	approx. 180 g
Protection class:	III
Protection rating:	IP20

### 2.2 Prohibited Environmental Conditions

- Condensation, humidity continuously too high (> 85% R.H.) and wetness
- Permanent presence of dust and combustible gases, vapours or solvents
- Ambient temperatures continuously too high (> +50 °C)
- Ambient temperatures continuously too low (< 0 °C)

## 2.3 Transport- & Storage Conditions

The Hydromette BL Compact RH-T may **only be stored in the packaging provided by the manufacturer or available from the manufacturer as an accessory**. The manufacturer shall not accept any liability or warranty for damage that may occur to the device or to the sensor system as a result of non-compliance.



### INFORMATION

In particular, **avoid keeping or storing the devices in foams not supplied by the manufacturer**, as these can damage the sensors due to possible outgassing and result in incorrect measurements.

## 2.4 Measuring Range

Humidity: 0 ... 100 % R.H.  
± 1.8 % R.H. in the range 10 to 90% R.H. (\*)

Air temperature: -20 ... 80 °C  
± 0.3 °C in the range 0 to 60 °C (\*)

(\*) Typical sensor accuracy

Sorption isotherms:

Cement screed	0,8 – 8,0	% by weight
Anhydrite screed	0.1 – 1.6	% by weight
Concrete	0.5 – 7.5	% by weight
Cement mortar	0.5 – 5.1	% by weight
Gypsum plaster	0.1 – 1.6	% by weight
Sand-lime brick	0.3 – 3.4	% by weight
Lime cement mortar	1.6 – 15.5	% by weight
Wood fibre insulation boards	5.7 – 199.9	% by weight
Mineral wool insulation	0.6 – 4.0	% by weight
Brick	0.2 – 5.5	% by weight
Hardwood / beech	2.7 – 27.3	% by weight
Softwood / pine	3.9 – 20.1	% by weight

## 3 General Information

### 3.1 Standards and Directives

This measuring instrument fulfils the requirements of the applicable European and national directives (2014/30/EU) and standards (EN 61010). Appropriate declarations and documentation are held by the manufacturer.

To ensure trouble-free operation of the measuring instrument and operational reliability, the user must carefully read and understand the operating instructions.

### 3.2 Warranty

The measuring instrument may only be operated under the specified climatic conditions. These are listed in [chapter 2.1 "Technical Data"](#) of the Hydromette".

This measuring instrument may only be used under the conditions and for the purposes that it has been designed for. Operational reliability and functionality are no longer ensured if the device is modified or adapted. Gann Mess- u. Regeltechnik GmbH shall not be liable for any damage arising from such modifications or adaptations. The risk is borne solely by the user.

The measuring instrument and any accessories may only be properly used as described in these instructions. Keep the device and accessories out of the reach of children!

The device must not be stored or operated in air that is corrosive or contains solvents!

The notes and tables in these instructions regarding permitted or normal humidity conditions in practice and the general definitions of terms have been taken from the specialist literature. Therefore, the manufacturer cannot guarantee the correctness. The conclusions to be drawn from the measurement results depend for each user on the individual circumstances and the knowledge gained from his professional experience.

The measuring instrument may be used in the residential and commercial sectors.

The measuring instrument may only be stored in the packaging provided by the manufacturer or available from the manufacturer as an accessory. The manufacturer accepts no liability for damage that may occur to the device or the sensor system as a result of non-compliance.

**Gann Mess- u. Regeltechnik GmbH accepts no liability whatsoever for damage caused by non-compliance with the operating instructions or by breach of the duty of care during transport, storage and handling when operating the device, even if this duty of care is not specifically referred to in the operating instructions.**

## 4 Description of the Product

The Hydromette BL Compact RH-T is a **precise thermo-hygrometer** for quick measurement of **relative humidity** and **air temperature**. It can be used to measure in bulk materials, air ducts and solids (e.g. masonry, concrete, etc.). Using programmed **sorption isotherms**, the weight and mass percentages can be determined for various building and insulation materials, as well as for hardwood and softwood.

Due to the **thin sensor pipe** (5.5 mm diameter), it is ideally suited for moisture analyses, damage evaluation, dehumidifying buildings and checking the readiness of floor and wall coverings.

An internal memory is available for storing data (min, max and hold function).

All models of the Hydromette BL Compact RH-T series feature a 3-line LCD display. In addition to the measured values of air humidity and air temperature, various calculated values such as (Dp), wood equilibrium moisture content (EMC) or absolute humidity (in g/m<sup>3</sup>) can be displayed.

The silicone buttons give haptic feedback for important functions.

The measuring instrument has a mini-USB port that can be used to download any firmware updates using the free GANN Dialog Pro PC software.

## 5 Device Layout and Button Assignment



Article no. 30012040

Figure 5-1: View of the Hydromette BL Compact RH-T

## 5.1 Display Symbols

### 5.1.1 Main Menu Symbols

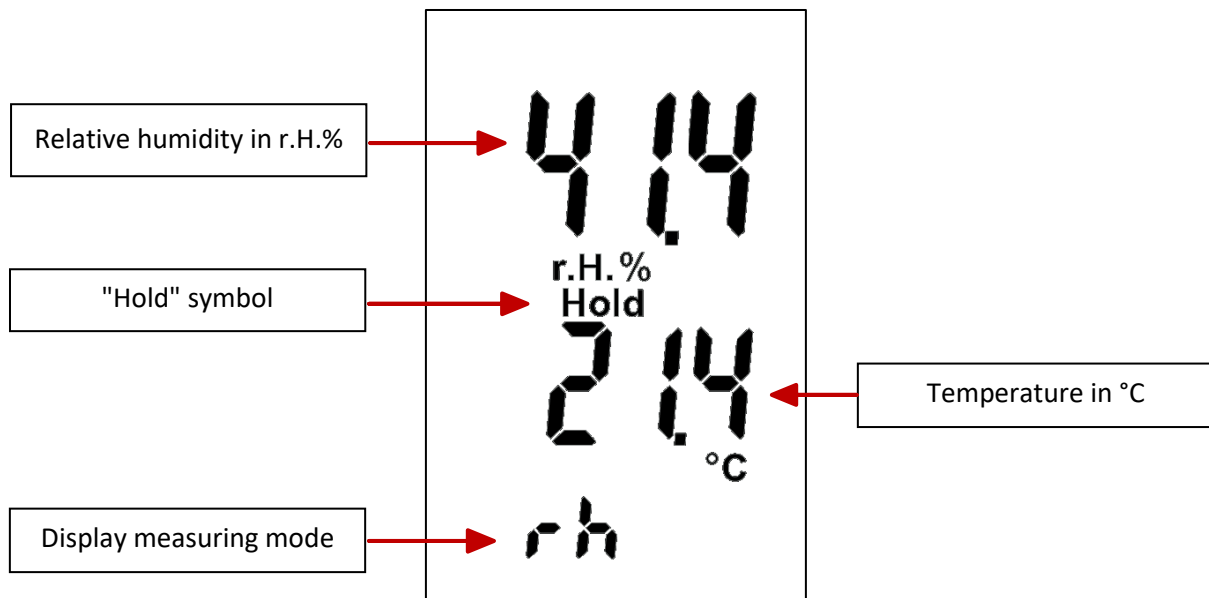

Figure 5-2: Main menu symbols

### 5.1.2 Other Symbols

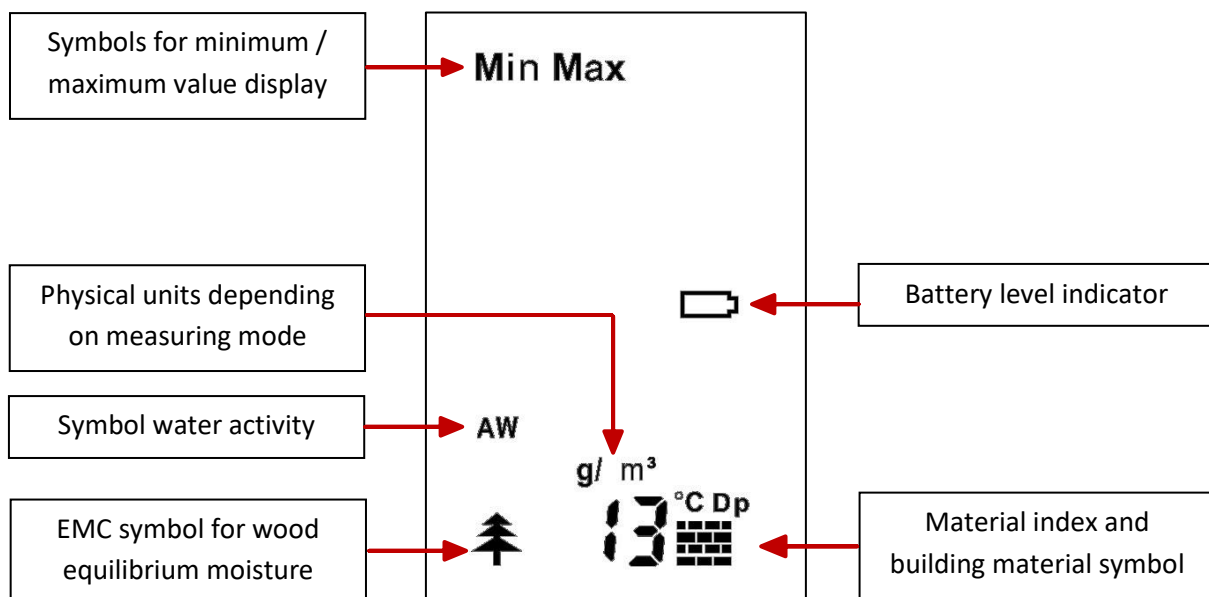



Figure 5-3 Other symbols

## 5.2 Switching the Device On and Off

The device is switched on and off by pressing the "On / Off" button . The device starts in the measuring menu or main menu. The measuring process can be carried out here [[see Chapter 5.3.1 "Measuring Menu \(Main Menu\)"](#)].

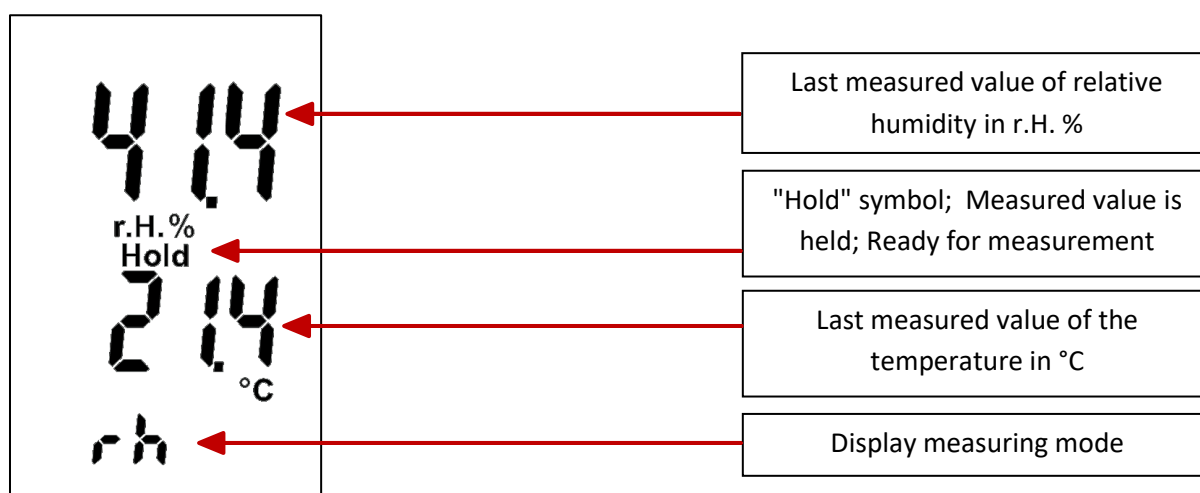

Figure 5-4: Standard measuring menu

## 5.3 Setting Menus

The following menu items can be selected one after the other by repeatedly pressing the "Down" button:

1. **Measuring Menu** (main menu): The measuring process can be performed here.
2. **Measuring mode selection**: The different measuring modes can be set here.
3. **Maximum value display**: The largest measured value is shown here.
4. **Minimal value display**: The smallest measured value is shown here.
5. **Memory Menu**: The last 5 measured values are stored here. The oldest value is overwritten after each measurement.

The menu items are selected in reverse order by pressing the "Up" button.



### 5.3.1 Measuring Menu (Main Menu)

After switching on, the device is in the measuring menu (main menu). The other menus can be accessed from here by pressing the "Up" or "Down" buttons.

In the measuring menu, the last measured values are displayed according to the measuring mode selection made with the associated units and the note "Hold".

A new measurement is started by pressing the "M" button (> 2 seconds).

During the measuring process, the "Hold" symbol disappears from the display. After releasing the "M" button, the measured value is held and automatically stored in the ring memory. This overwrites the oldest stored value. The "Hold" symbol is displayed again.

If the new measured value is larger than the previous maximum value, "Max" flashes on the display. If the new value should be accepted, the "M" button must be pressed *briefly* (< 1 second). If the value should not be saved, a new measurement can be started by *pressing and holding* (> 2 seconds) the "M" button without changing the previous maximum value.

If the new measured value is smaller than the previous minimum value, "Min" flashes on the display. If the new value should be accepted, the "M" button must be pressed *briefly* (< 1 second). If the value should not be saved, a new measurement can be started by *pressing and holding* (> 2 seconds) the "M" button without changing the previous minimum value.

### 5.3.2 Measuring Mode Selection



The measurement mode selection can be made in this menu. Various setting modes are available. The selected mode changes the display of the measuring menu. Depending on the mode, the appropriate physical dimension is also displayed. In detail, these are:

Measuring mode	Measuring mode display
"Relative humidity"	(rh / t / rh)
"Air temperature"	(rh / t / t)
"Dew point Dp"	(rh / t / dP)
"Equilibrium wood moisture content, EMC"	(rh / t / UGL)
"Absolute humidity"	(rh / Ah)
"Enthalpy"	(rh / En / En)
"Wet-bulb thermometer"	(t / to / to)
"Water activity"	(t / Aw / Aw)
"Building materials"	(t / building material symbol + material index)
"Wood"	(t / wood symbol + material index)

The various measuring modes are described in more detail on the following pages.

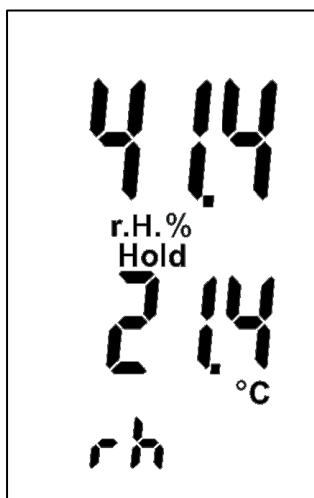

Figure 5-5: Measuring mode selection "relative humidity"

The device must be switched on and in the main measuring mode to be able to make the measuring mode settings. Press the "Down" button once to access the measuring mode selection. If the setting for the measuring mode should be changed now, the "M" button must be pressed *briefly* (< 1 second).

The measuring mode display flashes and can be set using the "Up" and "Down" buttons. The change is saved by *briefly* (< 1 second) pressing the "M" button again.

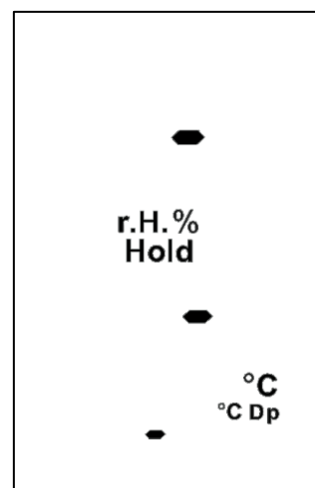

Figure 5-6: Display after a measuring mode change

After confirming the change, the display automatically jumps to the measuring menu of the (newly) selected measuring mode. This removes the values of the previous measuring mode from the display. Any stored "Max" or "Min" values remain in the memory of the respective measuring mode.

Now a new measurement can be performed by *pressing and holding* (> 2 seconds) the "M" button.

Different setting modes are available. The selected mode changes the display of the measuring menu. Depending on the mode, the appropriate physical dimension is also displayed. The measuring mode selection is designed as a ring menu, whereby the setting modes are scrolled through in the following order by pressing the "Up" button.

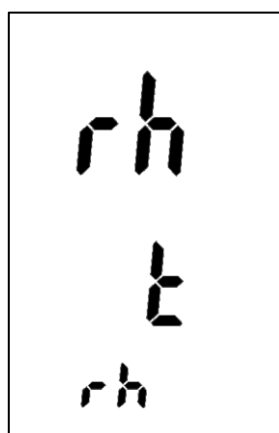

Figure 5-7: Measuring mode selection "relative humidity, rh"

Measuring mode "relative humidity, rh" (rh / t / rh):

The relative humidity (in r.H.%), the air temperature (in °C) and the measuring mode symbol "rh" are displayed.

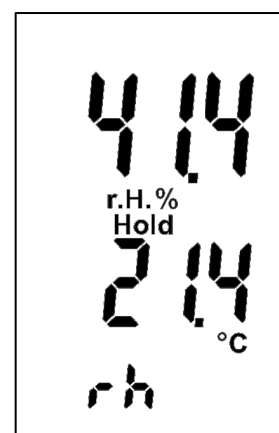

Figure 5-8: Measuring menu "relative humidity, rh"

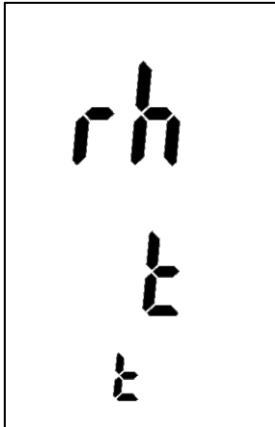

Figure 5-9: Measuring mode selection "air temperature, t"

Measuring mode "air temperature, t"  
(rh / t / t):

The relative humidity (in r.H.%), the air temperature (in °C) and the measuring mode symbol "t" are displayed.

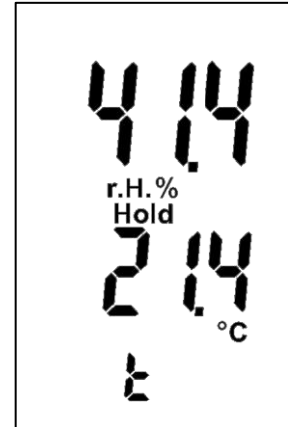

Figure 5-10: Measuring menu "air temperature, t"

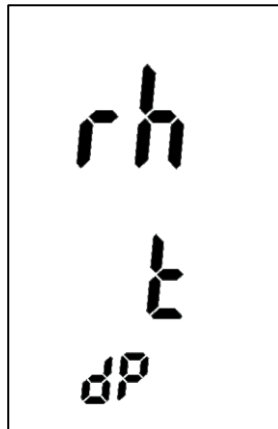

Figure 5-11: Measuring mode selection "Dew point, Dp"

Measuring mode "Dew point, Dp"  
(rh / t / dP):

The relative humidity (in R.H.%), the air temperature (in °C) and the dew point temperature (Dp in °C) are displayed.

See [dew point table](#) in the appendix.

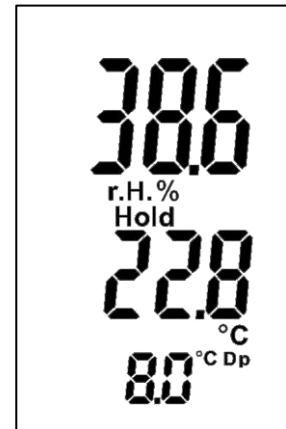

Figure 5-12: Measuring menu "Dew point, Dp"

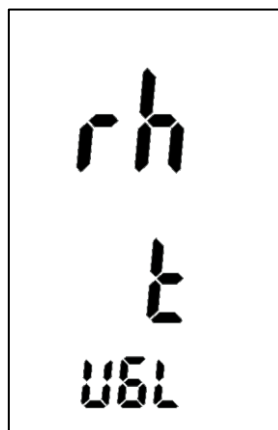

Figure 5-13: Measuring mode selection "Equilibrium wood moisture content, EMC"

Measuring mode "Equilibrium wood moisture content, EMC"  
(rh / t / UGL):

The relative humidity (in r.H.%), the air temperature (in °C) and the measuring mode symbol "Wood" with corresponding EMC value in weight % are displayed.

See [equilibrium wood moisture content table](#) in the appendix.

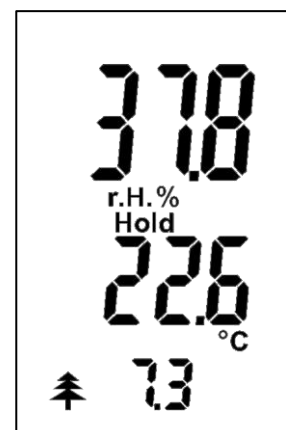

Figure 5-14: Measuring menu "Equilibrium wood moisture content, EMC"

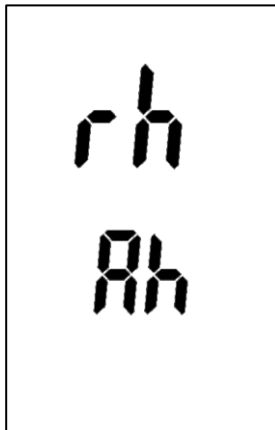

Figure 5-15: Measuring mode selection "absolute humidity, Ah"

Measuring mode "absolute humidity, Ah"  
(rh / Ah):

The relative humidity (in r.H.%), the absolute humidity (in g/m<sup>3</sup>, i.e. grams of water in 1m<sup>3</sup> of air) and the measuring mode symbol "Ah" are displayed.

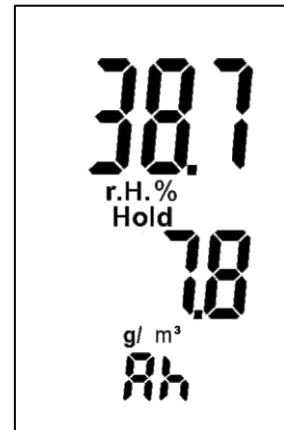

Figure 5-16: Measuring menu "absolute humidity, Ah"

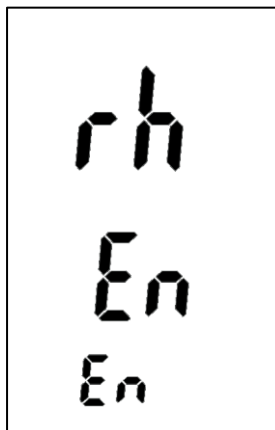

Figure 5-17: Measurement mode selection "Enthalpy, En"

Measuring mode "Enthalpy, En"  
(rh / En / En):

The relative humidity (in r.H.%), the energy content of the air/water vapour mixture (in kJ/kg) and the measuring mode symbol "En" are displayed.

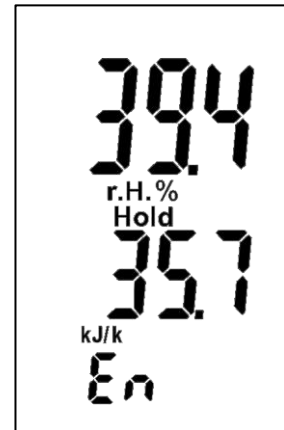

Figure 5-18: Measuring menu "Enthalpy, En"

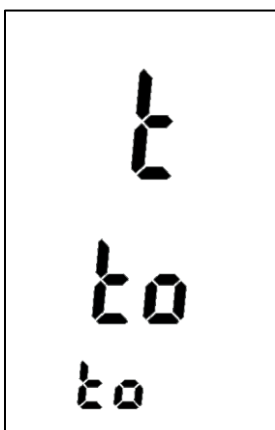

Figure 5-19: Measurement mode selection "wet-bulb thermometer, to"

Measuring mode "wet-bulb thermometer, to"  
(t / to / to):

The temperature (in °C), the wet bulb temperature (in °C) and the measuring mode symbol "to" are displayed.

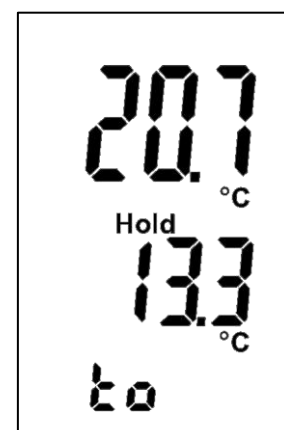

Figure 5-20: Measuring menu "wet-bulb thermometer, to"

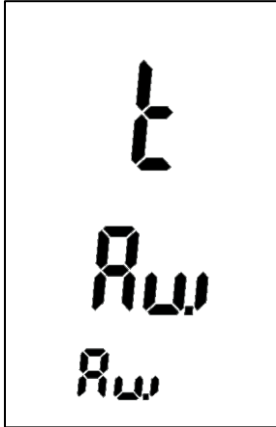

Figure 5-21: Measurement mode selection "water activity, Aw"

Measuring mode "water activity, Aw"

(t / Aw / Aw):

The temperature (in °C), the water activity (Aw) and the measuring mode symbol "Aw" are displayed.

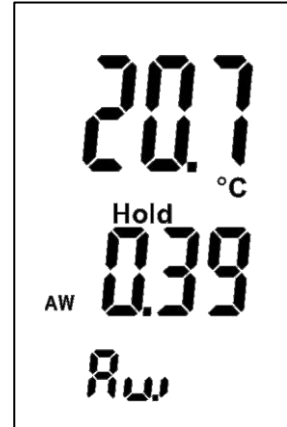

Figure 5-22: Measuring menu "water activity, Aw"

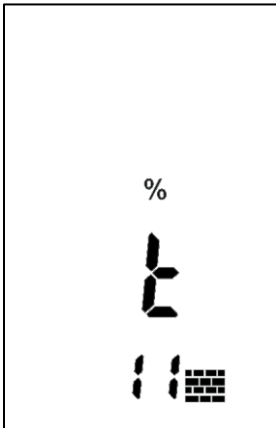

Figure 5-23: Measurement mode selection "building materials"

Measuring mode "building materials"

(% / t / building material symbol + material index):

The material moisture (in % by weight), the temperature (in °C) and the selected material are displayed.

Information on the selection options for building materials can be found in the [material table](#) in the appendix.



Figure 5-24: Measuring menu "building materials"

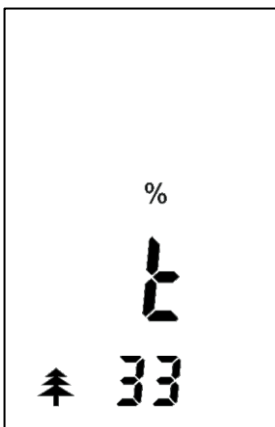

Figure 5-25: Measurement mode selection "wood"

Measuring mode "wood"

(% / t / wood symbol + material index):

The wood moisture (in weight %), the temperature (in °C) and the selected type of wood are displayed.

Information on the selection options for wood can be found in the appendix in the [material table](#) and [equilibrium wood moisture content table](#).



Figure 5-26: Measuring menu "wood"

### 5.3.3 Maximum Value Display



The highest measured value of a measurement series is displayed together with the "Max" display symbol.

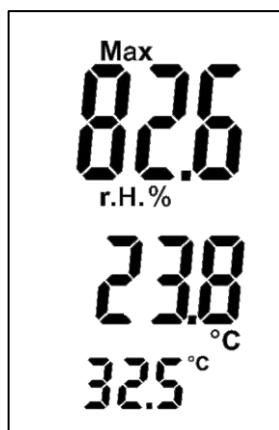

Figure 5-27: Maximum value display

A dash at the position of the measured value indicates that there is no maximum value (yet).

If an existing maximum value should be deleted, the displayed value must be selected by briefly (< 1 second) pressing the "M" button.

The value flashes and can now be deleted by pressing and holding (> 1 second) the "M" button.

A dash at the position of the measured value indicates the successful deletion of the value. The device returns to the measuring mode by briefly (< 1 second) pressing the "M" button again.

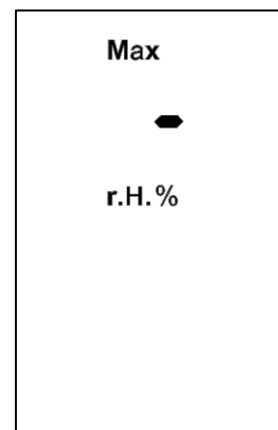

Figure 5-28: Deleted maximum value

A new measurement can then be performed immediately by pressing and holding (> 2 seconds) the "M" button.

Different setting modes are available. The selected mode changes the display of the measuring menu. Depending on the mode, the appropriate physical dimension is also displayed. According to the selected measuring mode and the associated physical units, the maximum values (and the minimum values) are also evaluated and saved. In detail, these are:

#### Measuring mode

- "Relative humidity" (rh / t / rh)
- "Air temperature" (rh / t / t)
- "Dew point Dp" (rh / t / Dp)
- "Equilibrium wood moisture content, EMC" (rh / t / UGL)
- "Absolute humidity" (rh / Ah)
- "Enthalpy" (rh / En / En)
- "Wet-bulb thermometer" ((t / to / to)
- "Water activity" (t / Aw / Aw)
- "Building materials" (t / building material symbol + material index)
- "Wood" (t / wood symbol + material index)

#### Maximum and minimum value

- Relative humidity in r.H.%
- Air temperature in °C
- Dew point temperature in °C
- EMC value in weight %
- Absolute humidity in g/m<sup>3</sup>
- Energy content in kJ/kg
- Wet-bulb temperature in °C
- Aw value (without dimension)
- Material moisture in weight %
- Wood moisture in weight %

### 5.3.4 Minimum Value Display



The lowest measured value of a measurement series is displayed together with the "Min" display symbol.

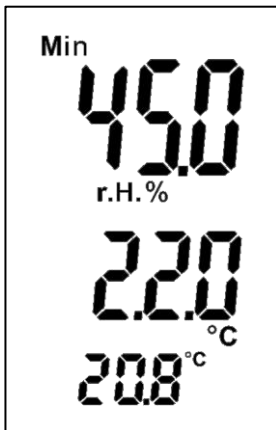

Figure 5-29: Minimum value display

A dash at the position of the measured value indicates that there is no minimum value (yet).

If an existing minimum value should be deleted, the displayed value must be selected by briefly (*< 1 second*) pressing the "M" button.

The value flashes and can now be deleted by pressing and holding (*> 1 second*) the "M" button.

A dash at the position of the measured value indicates the successful deletion of the value.

The device returns to the measuring mode by briefly (*< 1 second*) pressing the "M" button again.

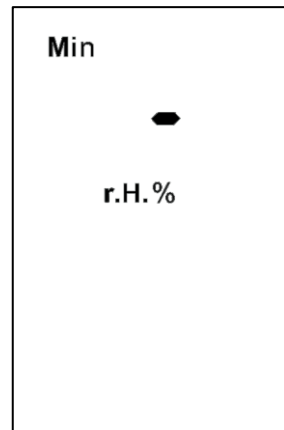

Figure 5-30: Deleted minimum value

A new measurement can then be performed immediately by pressing and holding (*> 2 seconds*) the "M" button.

### 5.3.5 Memory Menu



The ring memory symbol "o" and the corresponding memory location number are displayed.

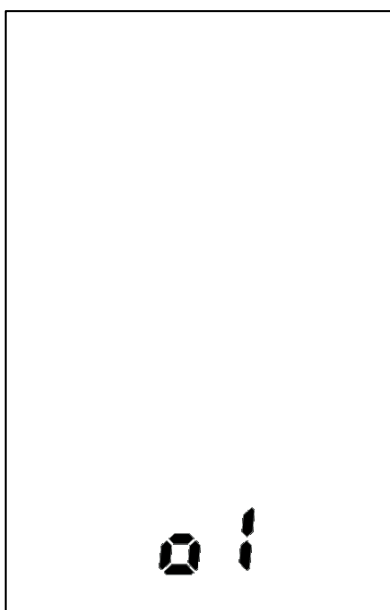

Figure 5-31: Memory location "o1"

As soon as you select the memory menu, the memory location number "o1" is displayed for approx. 1 second, and then the last measured saved value contained there is displayed.

By *briefly* (< 1 second) pressing the "M" button, the next memory location "o2" can be selected and the value it contains displayed.

The last 5 measured values are automatically saved and stored in the memory locations "o1" – "o5". The last measured value is in memory location "o1". The memory is designed as a ring memory. As soon as a sixth measured value is recorded, the oldest measured value in memory location "o5" is automatically removed from the memory.

After reaching the 5th memory location, the value of the 1st memory location is displayed again. Manual deletion of a memory value is not possible.

If the "M" button is pressed (and held) for *longer than 2 seconds*, the display of the memory value vanishes, only the memory location number is displayed. This signals that the user is still in the Memory Menu and not in the Measuring Menu. The memory value is retained in the background.

The saved values displayed can be identified by the fact that there is **no "Hold" symbol** in the display.



## 6 Other Functions

### 6.1 Automatic Switch-Off

If no button is pressed within approx. 90 seconds, the device switches off automatically. The current values are retained and are displayed again after the device is switched on again.

### 6.2 Battery Monitoring

If the battery symbol  is shown in the display, the battery is dead and must be replaced. A list of battery types that can be used can be found in chapter [„2.1 Technical Data“](#).

The device serial number is also located in the battery compartment.



#### INFORMATION

Under no circumstances should you use the mini-USB interface to charge an empty battery – the device does not have a charging circuit. It is only supplied with the typical USB voltage. No measurements are possible when the USB connection is plugged in.

### 6.3 Querying the Device Firmware

To query the firmware version of the device, the "Down" button ( $\nabla$ ) and the "Up" button ( $\Delta$ ) must be pressed simultaneously for approx. 2 seconds when the device is switched on. A "V" appears in the first line of the display, the firmware version number in the second line and a specific ID number (device-dependent) in the third line.

Briefly press the "M" button to return to measuring mode.

## 7 Installation of the PC-Software GANN Dialog Pro

The system requirements for the PC software GANN Dialog Pro are as follows:

- Operating system Windows 7 / Windows 8 / Windows 10 / Windows 11
- 2 GB free hard disk space
- 4 GB RAM memory
- USB-port
- Minimum screen resolution 1280 x 800 (1920 x 1080 is recommended)
- Internet connection for software downloads, updates and upgrades

The PC software GANN Dialog Pro is available for download free of charge at the following link:

<http://download-ota.gann.de/dlg>

Detail information about the PC software GANN Dialog Pro can be found in the associated user manual.

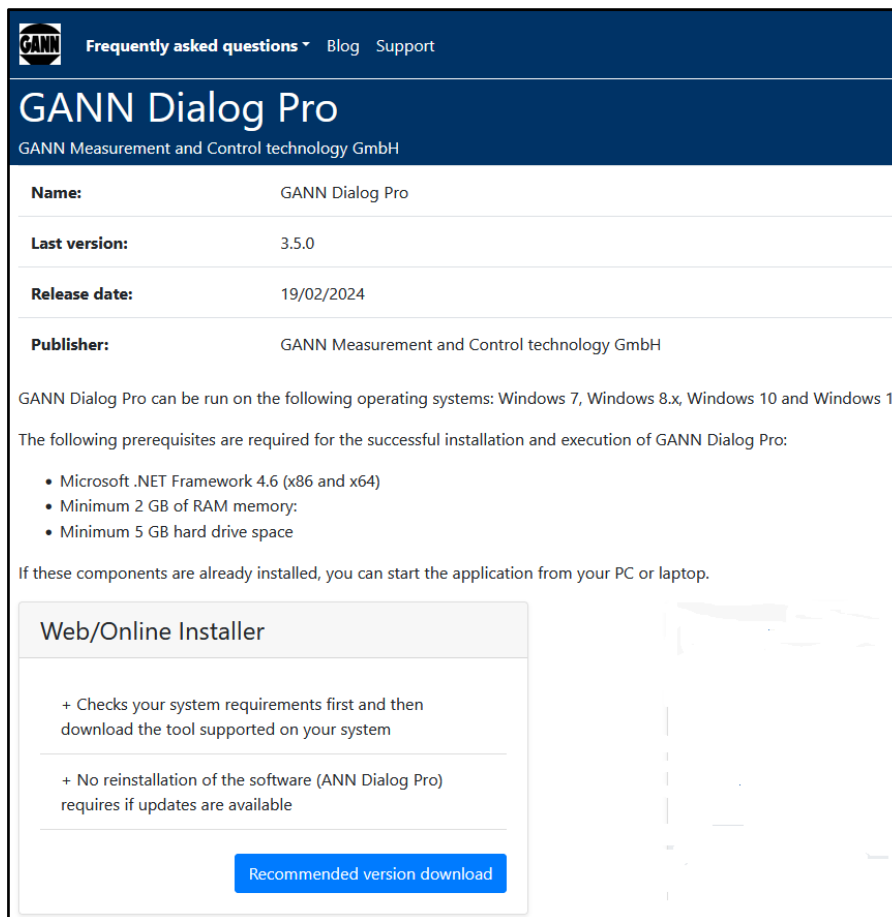

The screenshot shows the GANN website's download page for GANN Dialog Pro. The page has a dark blue header with the GANN logo and navigation links for 'Frequently asked questions', 'Blog', and 'Support'. Below the header, the title 'GANN Dialog Pro' is displayed in large white text, followed by 'GANN Measurement and Control technology GmbH'. A table lists the software details:

<b>Name:</b>	GANN Dialog Pro
<b>Last version:</b>	3.5.0
<b>Release date:</b>	19/02/2024
<b>Publisher:</b>	GANN Measurement and Control technology GmbH

Below the table, the text states: 'GANN Dialog Pro can be run on the following operating systems: Windows 7, Windows 8.x, Windows 10 and Windows 11.' It then lists prerequisites for installation: 'The following prerequisites are required for the successful installation and execution of GANN Dialog Pro:'

- Microsoft .NET Framework 4.6 (x86 and x64)
- Minimum 2 GB of RAM memory;
- Minimum 5 GB hard drive space

It notes that if these components are already installed, the application can be started from a PC or laptop. A 'Web/Online Installer' section lists two benefits: '+ Checks your system requirements first and then download the tool supported on your system' and '+ No reinstallation of the software (ANN Dialog Pro) requires if updates are available'. A blue button labeled 'Recommended version download' is positioned at the bottom of this section.

Figure\_7\_1: Download of the PC software GANN Dialog Pro

If you click on the "Download recommended version" button, you will be asked whether you want to download the software. Confirm this with "Save file" to start the download. Perform the installation steps of setup.exe.

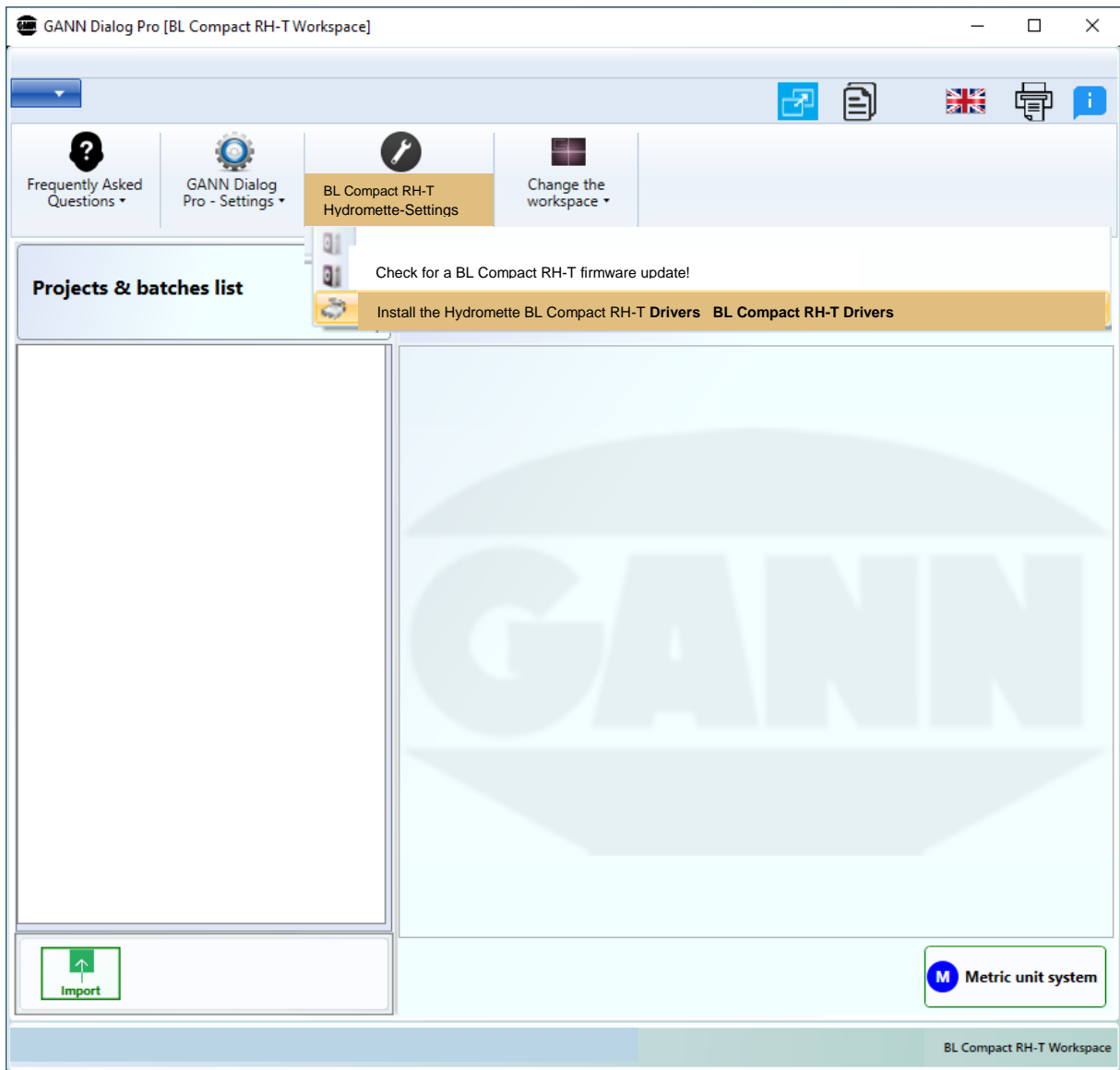

Figure\_7\_2: Download device drivers of the Hydromette BL Compact RH-T

To download the device drivers, the working range of the desired Hydromette must first be selected in the menu item "Select working range".

## 8 USB-Communication with a PC

The software "GANN Dialog Pro" must be installed before the Hydromette BL Compact RH-T is connected to a PC (see chapter 7, [Figure 7-1](#)). GANN Dialog Pro includes the associated device drivers, which must also be installed (see chapter 7, [Figure 7-2](#))

If the Hydromette BL Compact RH-T is connected to a PC with Windows operating system when it is switched off, the Hydromette starts in USB mode. No measurements can be performed during the communication with the PC. The GANN Dialog Pro software now provides the possibility to update the firmware of the Hydromette BL Compact RH-T via the Internet. The Hydromette remains in USB mode after disconnecting the USB cable. The Hydromette will only restart in standard mode after it has been switched off and switched on again.

### **The USB connection must not be disconnected during the communication with the PC!**



#### **INFORMATION**

If the connection is disconnected during a firmware update, the Hydromette BL Compact RH-T can no longer be started. In this case, the problem can be solved by reconnecting to a PC and installing the firmware. If it is not possible to install firmware on the device after several attempts, GANN Support must be contacted.

## 9 Application Notes

### 9.1 General Notes on Humidity / Air Temperature Measurement

Humidity, also known as air humidity, is the water vapour content of the air. Like any other substance, air only has a limited capacity to absorb water. This limit is known as the saturation limit. Above the saturation point, the excess water content accumulates in the form of very fine water droplets (condensate). The temperature plays a decisive role here.

The absolute humidity is given in  $\text{g}/\text{m}^3$  and its maximum value depends on the temperature. It increases at higher temperatures and decreases accordingly at lower temperatures. Relative humidity, on the other hand, indicates the ratio between the current absolute humidity and the maximum vapour content (saturation humidity), i.e. what percentage of the maximum water vapour content in the air has been reached. Relative humidity is given in % RH (relative humidity) or % RH (relative humidity).

The relative humidity has an effect on human perception. In this context, we speak of a comfort range. This range lies approximately at a temperature between 20 °C and 24 °C and a relative humidity between 40 % and 60 % RH.

Physically, warm air can absorb more moisture than cold air. This means that when the warm air cools down, moisture may be released which condenses on surfaces or building components. If this happens in the long term, walls, for example, become damp, which can lead to the formation of mould.

The humidity affects the material moisture. If a material is in a certain ambient climate for a longer period of time, it takes on a moisture content corresponding to this climate, which is also referred to as equilibrium moisture or practical moisture content. On reaching the equilibrium moisture content, the material no longer loses moisture if the surrounding climate remains the same and also no longer absorbs any moisture. The equilibrium values generally mentioned refer to a climate of 20 °C and 65 % relative humidity. However, these values must not be confused with the values at which the material can be worked or processed.

When evaluating the moisture of a material, the surrounding climate is the primary consideration. All materials are subject to continuously changing temperatures and air humidity. The impact on the material moisture significantly depends on the thermal conductivity, the thermal capacity, the resistance to water vapour diffusion and the hygroscopic properties of the material.

The "expected moisture content" of a material is the moisture level that corresponds to the average of the equilibrium moisture content under changing climatic conditions that it is continuously exposed to. The humidity values in living spaces in Central Europe are approx. 45–65 % RH in summer and approx. 30–45 % RH in winter. These fluctuations can cause damage in centrally heated rooms in winter (see also table in the appendix: [Comparison Graph of Humidity – Material Moisture Content](#)).

## 9.2 Using the Hydromette BL Compact RH-T

### Measure:

Press and hold the "M" button for longer than 2 seconds. A measurement process is carried out as long as the Measure button is kept pressed. After releasing the "M" button, the measurement process is interrupted and the "Hold" symbol is displayed.

### Cleaning:

The inserted filter fabric of the Hydromette BL Compact RH-T is sensitive to mechanical damage and offers no protection against liquids. Under no circumstances should it be washed out with cleaning fluids or blown free with compressed air if it becomes dirty. Cleaning should only be carried out from the outside using a soft brush. If the filter fabric is damaged or heavily soiled/encrusted, it can only be replaced at the factory.

### Sinter filter:

The sintered filter, which is available as an optional accessory (see [Accessories chapter](#)), offers increased protection for use with dusty air or coarse dirt as well as for measurement at high air velocities (from 2 m/s). The filter can be washed out in residue-free cleaning liquids and/or blown free with compressed air if it becomes dirty. If the sintered filter is used, the response times are considerably longer. The diameter of a drill hole must be adapted (min. 12 mm).

### Measuring error:

Measurements below 20% R.H. and above 80% R.H. should preferably not be taken over a prolonged period of time (continuous measurements). Other measurement falsifications can occur due to shielding with body parts (e.g. hand) as well as blowing or speaking/breathing in the direction of the sensor.

### Caution:

- The sensor is not designed for continuous measurements above 80% R.H. (longer than approx. 36 hours at a time without regeneration at 30-40% R.H. in the same time frame).
- The measuring device may only be exposed to temperatures above 50 °C for short periods.

### 9.2.1 Precautions

The sensor can be irreparably damaged by various mechanical or environmental influences.

These include in particular:

- direct contact of the sensor with the fingers
- direct contact with solid or sticky materials or objects
- measurement in environments containing solvents, oil vapours or other high levels of contaminants
- storing the sensor in foam materials NOT provided by us
- removal from the drill hole too hastily. This can cause the sensor cap to get stuck in the drill hole and tear off. The entire sensor pipe and sensor may be irreparably damaged
- Tearing off the sensor cap due to a drill hole that is too narrow, resulting in damage to the sensor pipe and the sensor

## 9.3 Measuring Relative Humidity

The response speed of the sensor is very high, so that even small air flows (door gap, leaky window, etc.) influence the measured value display. An absolute standstill of the display can therefore only be achieved in a climate box.

The response time of the humidity sensor in slightly moving air is approx. 8 seconds\* at an ambient temperature of 25 °C for 63 % of the humidity difference. The filter used to protect the sensor (in RH-T models and the TF-Sticks 16 K-25 M / P) delays the response time. By swivelling the device (ventilation of the sensor), the response time can be shortened in the event of air standstill or low air velocity.

\*Specifications of the sensor manufacturer



#### INFORMATION

For particularly precise measurements, especially at temperatures below room temperature (20–25 °C) or if there are significant temperature differences between the intrinsic temperature of the measuring instrument and the ambient climate, the device should be exposed to the ambient climate for approx. 10 to 15 minutes or until the temperature has equalised. The sensor adapts to the respective climate even when it is not switched on.

## 9.4 Equilibrium Wood Moisture Content (EMC)

Equilibrium wood moisture content is the moisture content adopted by the wood when it is exposed to constant climate (constant humidity and constant temperature) for sufficiently long time.

The device can simultaneously display relative humidity, temperature, and equilibrium wood moisture content. This makes it easier for parquet installers and interior finishers to assess whether wooden components may be exposed to the existing ambient climate or whether damage to the wood, such as cracking, shrinkage or swelling, is to be expected. An appropriate [Equilibrium wood moisture content table](#) can also be found in the appendix.

## 9.5 Water Activity (Aw)

Water activity is defined as the relative humidity that has to prevail in the surrounding medium to prevent an exchange of water between air and material. In practice, it corresponds approximately to the equilibrium moisture content of a material, but is not given as a percentage value but as a value between 0 and 1 aw.

The water activity is a measure of the degree of freedom of the free water (of various types) bound in a material.

The Aw value is an important measure concerning the shelf life of foodstuffs and influences the incidence of microorganisms that have differing requirements for freely available water. With a lack of free water, growth processes are slowed or prevented, whereas others are accelerated. Therefore, the Aw value is an important measure in the chemical and food industries.

## 9.6 Measuring Air Temperature

The response speed of the sensor is very high, so that even small air flows (door gap, leaky window, etc.) influence the measured value display. An absolute standstill of the display can therefore only be achieved in a climate box.

The response time of the air temperature sensor in moving air is approx. 5–30 seconds for 63 % of the temperature difference\*. The filter used to protect the sensor (in RH-T models and the TF sticks 16 K-25 M / P) delays the response time.

\*Specifications of the sensor manufacture



### INFORMATION

For particularly precise measurements, especially at temperatures below room temperature (20–25 °C) or if there are significant temperature differences between the intrinsic temperature of the measuring instrument and the ambient climate, the device should be exposed to the ambient climate for approx. 10 to 15 minutes or until the temperature has equalised. The sensor adapts to the respective climate even when it is not switched on.



## 9.7 Dew Point Temperature

The dew point temperature is the temperature at which the air is saturated with water vapour. The relative humidity is then 100%. If this dew point temperature is undershot, the moisture contained in the air condenses on a component / surface. The dew point temperature is generally lower than the air temperature, except at 100% R.H. where both temperatures are the same. As the relative humidity increases, the dew point temperature approaches the air temperature.

The display of the calculated dew point in the measuring modes "Dew point, Dp" (rh / t / Dp) is based on the relative humidity and air temperature parameters. A [dew point table](#) for calculating condensation can also be found in the Appendix.

## 9.8 Enthalpy

Enthalpy (En) is a measure of the energy content of air-water vapour mixtures, in kJ per kg.

## 9.9 Wet-Bulb Thermometer

The **wet-bulb temperature** is the lowest temperature that can be achieved with evaporative cooling.

The release of water from the damp surface is in balance with the ability of the surrounding atmosphere to absorb water and thus saturates the surrounding air with water vapour. Because of the evaporative chill, the wet-bulb temperature is dependent on the relative air humidity and lies under the air temperature. The temperature difference is the larger, the drier the surrounding air is. Using the temperature difference, the relative humidity can thus be determined.

The wet-bulb temperature (in the drawing (**T2**)) is determined with a psychrometric measurement with a thermometer provided with a damp material cover.

The wet-bulb temperature is mainly of interest where large amounts of liquids evaporate, such as in wood drying machinery.

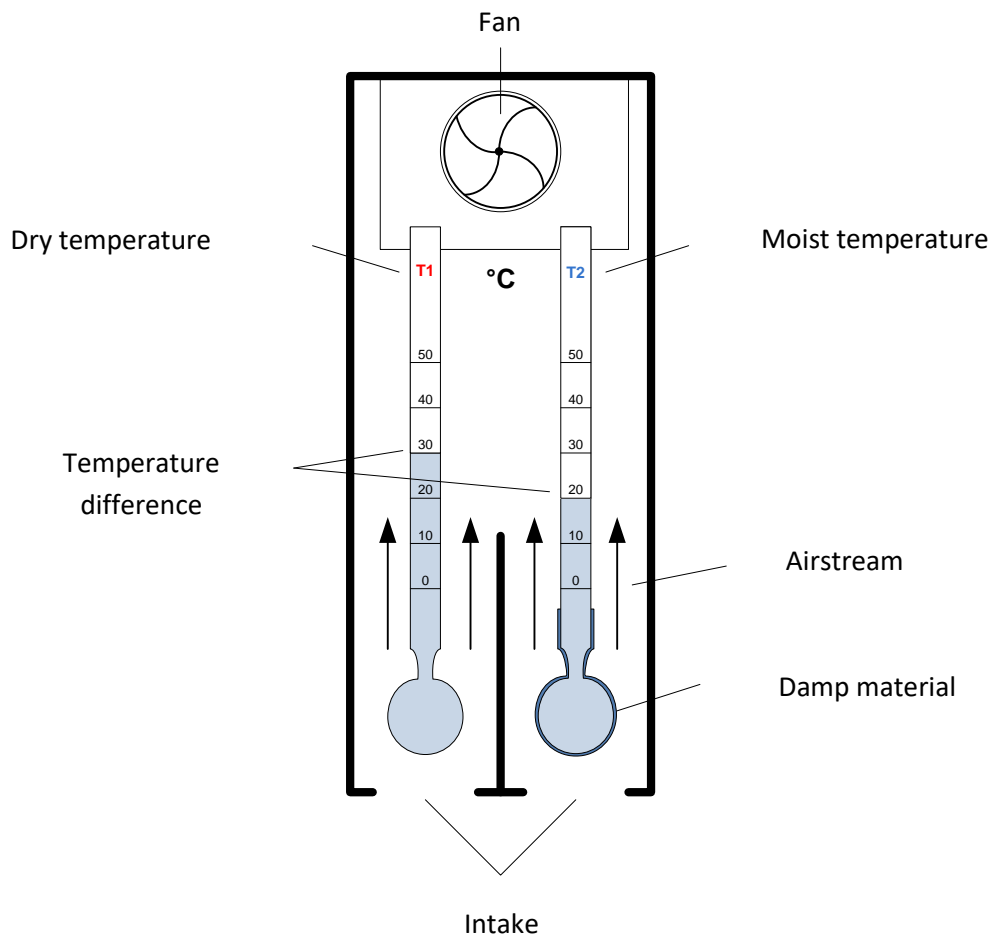

Figure 9-1: Aspiration psychrometer

## 9.10 Measuring the relative Air Humidity in Building Materials

The method for measuring the relative air humidity/equilibrium moisture content in screeds has been used for a long time in Great Britain and the Scandinavian countries. Compared to the non-destructive measurement or the resistance measurement, it is, however, more time-consuming and requires suitable drilled holes. On the other hand, it provides very reliable results when an equilibrium moisture content is sought in the drill hole.

This method is also used for depth measurements in older building materials (e.g. sandstone, quarry stone, damp walls, etc.) where the resistance measurement method does not provide reproducible results.

The "drill hole method" increases safety where there is insufficient information about the composition of the screed / building substance.

For measurements over a long period at multiple points or at different depths, drilled holes should be closed.

The measurement results obtained via the humidity / air temperature measurement are then converted into weight percentages using **sorption isotherms**. Sorption isotherms describe the equilibrium state of the sorption of a material on a surface at a constant temperature. In this equilibrium state, the relationship between water content and equilibrium moisture content of the surface (i.e. of the material) can be described and represented by a curve. Each moisture value can be allocated to an appropriate water content of the material using this curve.

Different materials also have different sorption behaviour depending on the specific properties of the material.

As these processes are extremely complex, the sorption curves are obtained empirically, i.e. they relate to practical data and experience. For each material, its own characteristic curve must be obtained experimentally.

A [material table](#) can be found in the appendix. For materials not included in it, there are currently no sorption isotherms confirmed or checked by us.

### 9.10.1 "Drill hole" Method

For the measurement, a hole with a diameter of min. 7 mm or 8 mm (flex) and a depth of at least 40 mm is drilled. A sharp drill bit, a high impact rate and a low speed are important.

If the drill hole is very hot, wait for the temperature to equalise before measuring. Before measuring in the drill hole, it must be carefully cleaned of drilling dust and blown out. There must be no free water in the hole.

The drill hole should then be sealed to prevent air exchange with the environment. The equilibrium moisture content in the hole is indicated after approx. 30 minutes, given temperature equilibrium (same temperature in material being measured and the tube sensor).

Without air circulation, e.g. when measuring in a drill hole, the response time of the sensor is extended. It is recommended to read an initial value after approx. 1 minute and to measure again in increments of 3–5 minutes until a constant value has been established.



**WARNING**

**Before** drilling holes for probes into walls, ceilings, floors, etc., make absolutely sure by suitable means that there are **no** electrical cables, water pipes or other supply lines in this location.

## 10 Accessories

**Connection cable MK 26** – Length: 1.80 m (order no. 31016920)



For device connection to a USB port.

### Sintered filter



Inner  $\varnothing$  5.5 mm / outer  $\varnothing$  10 mm (order-no. 31014601) for models RH-T 165/320

Filter cap for protection in dusty air and for measurement at high air velocities.

## 11 Appendix

### 11.1 Material-Table

Material index	Material
11	Cement screed in weight %
12	Anhydrite screed in weight %
13	Concrete in weight %
14	Cement mortar in weight %
17	Gypsum plaster in weight %
19	Lime sand brick in weight %
20	Lime cement mortar in weight %
22	wood fibre insulation panels in weight %
23	Mineral wool insulation in weight %
25	Brick in weight %
32	Hardwood / Beech
33	Softwood / Spruce

### 11.2 Wood Moisture Equilibrium

Wood Moisture Equilibrium					
Air temperature in °C					
	10 °C	15 °C	20 °C	25 °C	30 °C
Relative air humidity	Wood moisture content				
<b>20%</b>	4.70%	4.70%	4.60%	4.40%	4.30%
<b>30%</b>	6.30%	6.20%	6.10%	6.00%	5.90%
<b>40%</b>	7.90%	7.80%	7.70%	7.50%	7.50%
<b>50%</b>	9.40%	9.30%	9.20%	9.00%	9.00%
<b>60%</b>	11.10%	11.00%	10.80%	10.60%	10.50%
<b>70%</b>	13.30%	13.20%	13.00%	12.80%	12.60%
<b>80%</b>	16.20%	16.30%	16.00%	15.80%	15.60%
<b>90%</b>	21.20%	21.20%	20.60%	20.30%	20.10%

### 11.3 Dew Point Table

Air- temperature  °C	Dew point temperature in °C at a relative humidity of:							Saturation moisture = amount of water in g/m <sup>3</sup>
	30 %	40 %	50 %	60 %	70 %	80 %	90 %	
	°C	°C	°C	°C	°C	°C	°C	
30	10.5	14.9	18.5	21.2	24.2	26.4	28.2	30.4
28	8.7	13.1	16.7	19.5	22.0	24.2	26.2	27.2
26	7.1	11.3	14.9	17.6	19.8	22.3	24.2	24.4
24	5.4	9.5	13.0	15.8	18.2	20.3	22.2	21.8
22	3.6	7.7	11.1	13.9	16.3	18.4	20.3	19.4
20	1.9	6.0	9.3	12.0	14.3	16.5	18.3	17.3
18	0.2	4.2	7.4	10.1	12.4	14.5	16.3	15.4
16	-1.5	2.4	5.6	8.2	10.5	12.5	14.4	13.6
14	-3.3	-0.6	3.8	6.4	8.6	10.6	12.4	12.1
12	-5.0	-1.2	1.9	4.3	6.6	8.5	10.4	10.7
10	-6.7	-2.9	0.1	2.6	4.8	6.7	8.4	9.4
8	-8.5	-4.8	-1.6	0.7	2.9	4.8	6.4	8.3
6	-10.3	-6.6	-3.2	-1.0	0.9	2.8	4.4	7.3
4	-12.0	-8.5	-4.8	-2.7	-0.9	0.8	2.4	6.4
2	-13.7	-10.2	-6.5	-4.3	-2.5	-0.8	0.6	5.6
0	-15.4	-12.0	-8.1	-5.6	-3.8	-2.3	-0.9	4.8

Dew point temperatures depending on air temperature and relative humidity for condensation calculation.

## 11.4 Equilibrium Moisture Values in Percent by Weight

<b>Building materials</b>	at 20°C approx. 50% RH	at 20°C approx. 65% RH	at 20°C approx. 90% RH
Cement screed (sealed, applied rel. dry)	1.5	1.7 - 1.8	3.1
Cement screed (unsealed, applied rel. wet)	2.0	2.4 - 2.6	3.8
Cement mortar 1: 3	1.5	1.7 - 1.8	3.2
Lime mortar 1: 3	1.6	1.8 - 1.9	3.4
Gypsum plaster, plasterboard	0.5	0.6 - 0.7	1.0
Gypsum screed	0.6	0.8 - 0.9	1.3
Magnesite screed	7.0	8.3 - 8.7	13.0
Stone wood according to DIN	11.0	13.5 - 14.5	16.7
Gas concrete (Co Hebel)	8.5	11.0 - 12.0	18.0
Elastizell screed	1.6	1.8 - 2.2	2.8
Anhydrite screed	0.5	0.6 - 0.7	0.9
Concrete (200 kg cement/m <sup>3</sup> sand)	1.4	1.6 - 1.7	3.0
Concrete (350 kg cement/m <sup>3</sup> sand)	1.6	1.8 - 2.0	3.4
Concrete (500 kg cement/m <sup>3</sup> sand)	1.8	2.0 - 2.2	3.8



## 11.5 Comparison Graph of Humidity – Material Moisture Content

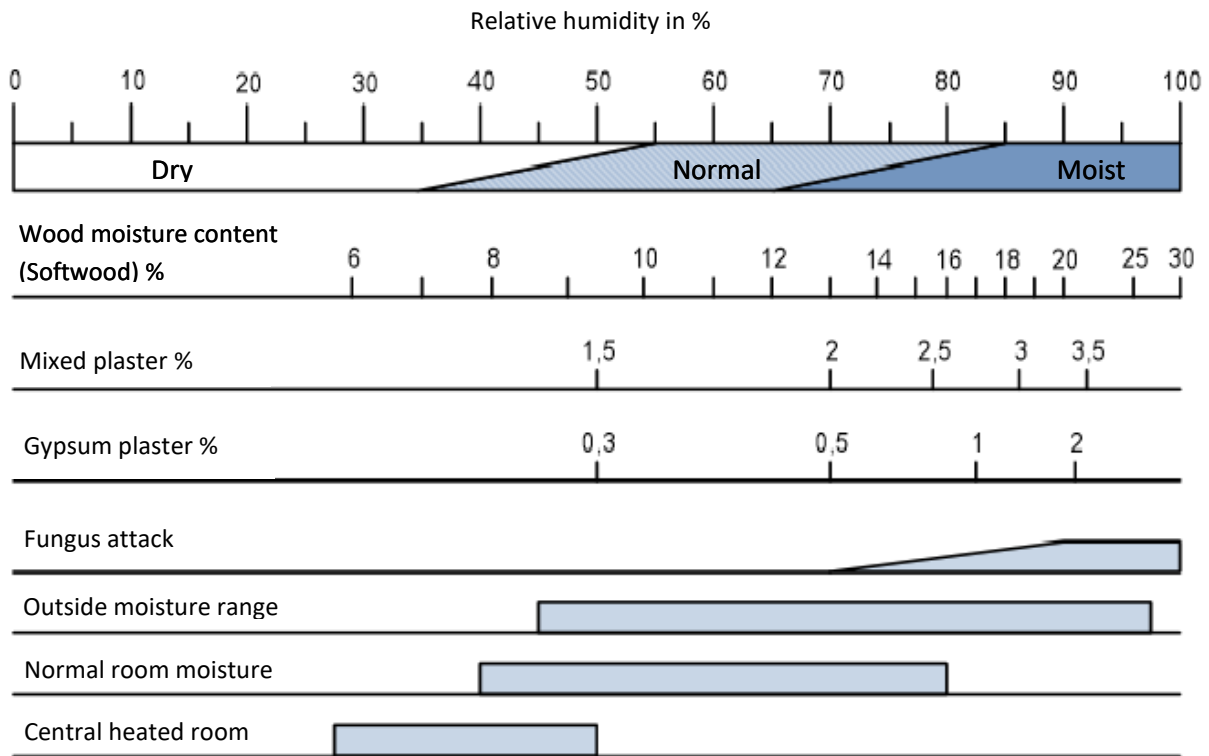

### Notes on graphic:

The areas shown in the graphic mean:



### White zone: dry

Equilibrium moisture.

### Pale zone: equilibrium zone

Caution! Non-diffusing coverings or adhesives should not be used. Please ask the respective manufacturer.

### Dark zone: moist

Machining or processing at very high risk!

## 11.6 References

We would like to specifically draw your attention to the fact that the literature mentioned is only an extract and is not complete. The individual titles must also be viewed with regard to the respective usage case.

Trocknungstechnik, Erster Band, Springer-Verlag, Berlin, ISBN: 3-540-08280-8

Wassertransport durch Diffusion in Feststoffen, H. Klopfer, Bauverlag GmbH, Wiesbaden, ISBN: 3-7625-0383-4

Schadensanalysen, H. Fischer, expert Verlag, ISBN: 3-8169-0928-0

Schall, Wärme, Feuchte, Gösele/Schüle, Bauverlag GmbH, ISBN: 3-7625-2732-6

## 11.7 General Concluding Remarks

The notes and tables in these operating instructions on permitted or normal humidity conditions in practice and the general definitions of terms have been taken from the specialist literature. No responsibility can therefore be taken by the manufacturer of the measuring device for the correctness of this information.

The conclusions to be drawn from the measurement results are related to the individual conditions and the knowledge from professional experience for each user. In cases of doubt, for example concerning the permitted moisture content in coating or screed substrates when laying floor coverings, it is recommended to contact the manufacturer of the coating or floor covering and to take account of the recommendations of the trade associations/guilds.

### Please note:

The instructions for use for the device and any accessories should be carefully observed, as supposed simplifications in handling often lead to measurement errors.

- Subject to technical changes-

Status: December2024



**GANN MESS- U. REGELTECHNIK GMBH**

70839 GERLINGEN SCHILLERSTRASSE 63 INTERNET: <http://www.gann.de>

Verkauf National: TELEFON 071 56-49 07-0 TELEFAX 071 56-49 07-40 E-MAIL: [verkauf@gann.de](mailto:verkauf@gann.de)

Verkauf International: TELEFON +49-71 56-49 07-0 TELEFAX +49-71 56-49 07-48 E-MAIL: [sales@gann.de](mailto:sales@gann.de)

## 12 EU Declaration of Conformity



Document no. / order no.: 30012040

Product identifier: **HYDROMETTE BL Compact RH-T 165**

We declare that the hand-held meter and related accessory correspond with the protection requirements and if used according to their intended purpose, comply with the requirements of the directives:

2014/30/EU          EMC Directive

2011/65/EU          RoHS

Applied harmonized standards:

EN 61326-1 : 2013    General EMC requirements

EN IEC 63000 : 2018 Restriction of hazardous substances

This declaration is given in responsibility for:

**Gann Mess- und Regeltechnik GmbH**

**Schillerstr. 63**

**70839 Gerlingen**

**Germany**

issued by:

name: Michael Gann

Position in the company of manufacturer: Managing Director

Place / date: Gerlingen, 12 December 2024



(Legally valid signature)