

Operating Instructions

Version 3.0



HYDROMETTE

BL H 40



EN



GANN MESS- U. REGELTECHNIK GMBH

70839 GERLINGEN

SCHILLERSTRASSE 63

INTERNET: <http://www.gann.de>

Verkauf National: TELEFON 07156-4907-0
Verkauf International TELEFON +49 7156-4907-0

TELEFAX 07156-4907-40
TELEFAX +49 7156-4907-48

EMAIL verkauf@gann.de
EMAIL sales@gann.de

Disclaimer

GANN Mess- u. Regeltechnik GmbH does not make any assurances or warranties with respect to this document and, to the extent permitted by law, limits its liability for breach of any implied warranty to the replacement of this document with another. Furthermore, GANN Mess- u. Regeltechnik GmbH reserves the right to revise this publication at any time without having to notify anyone about such revisions.

The information provided in this documentation includes general descriptions and/or technical characteristics for the performance of the equipment described herein. This documentation cannot be used as a proper assessment of the suitability or reliability of the equipment for a specific application by a user and must not be used as a substitute for such an assessment. It is the responsibility of any such user to carry out an appropriate and complete risk assessment, evaluation and testing of the equipment with regard to his specific application. Neither GANN Mess- u. Regeltechnik GmbH nor any of its partner or subsidiary companies can be made responsible or liable in the event of misuse of the information contained in this document.

All relevant national, regional and local safety regulations must always be observed when installing and using this device. For reasons of safety and to ensure compliance with the documented system data, only the manufacturer is authorised to carry out repairs to components. Failure to observe this information may result in injury or damage to the equipment.

Copyright © 2024 GANN Mess- u. Regeltechnik GmbH, Gerlingen

All rights reserved. No part of this publication may be reproduced, processed or distributed in any form, including photocopying, recording or any other electronic or mechanical process, without the written permission of the publisher. Requests for permissions must be made in writing to the publisher at the address given on the title page.



Table of Contents

1	Foreword	5
1.1	User Description.....	5
1.2	Intended Use	5
1.3	Non-Intended Use	5
1.4	Explanation of the General Warnings	6
1.5	General Safety Instructions.....	7
1.5.1	Persons at Risk.....	7
1.5.2	Preparation and Start-up.....	8
1.5.3	Use / Operation	8
1.5.4	Care, Maintenance and Inspection	9
1.5.5	Troubleshooting	9
1.5.6	Disposal	9
1.6	Specific Warnings	10
2	Specifications.....	11
2.1	Technical Data	11
2.2	Prohibited Environmental Conditions.....	11
2.3	Transport- & Storage Conditions.....	11
2.4	Measuring Range.....	12
3	General Information.....	13
3.1	Standards and Directives.....	13
3.2	Warranty	13
4	Description of the Product	14
5	Device Layout and Button Assignment	15
5.1	Display Symbols.....	16
5.1.1	Main Menu Symbols.....	16
5.1.2	Other Symbols	16
5.2	Switching the Device On and Off	17
5.3	Setting Menus	17
5.3.1	Measuring Menu (Main Menu)	18
5.3.2	Material Setting.....	19
5.3.3	Compensation Temperature	20
5.3.4	Maximum Value Display.....	21
5.3.5	Minimum Value Display.....	22

5.3.6	Memory Menu.....	23
6	Other Functions.....	24
6.1	Automatic Switch-Off.....	24
6.2	Battery Monitoring.....	24
6.3	Querying the Device Firmware.....	24
7	Application Notes.....	25
7.1	Comparative Measurement or Reference Measurement.....	25
7.2	General Information on Wood Moisture Measurement.....	26
7.3	Notes on resistance-based Measuring Wood Moisture.....	26
7.3.1	Test Adapter for resistance-based Wood Moisture Measurement.....	27
7.4	Using the Hydromette BL H 40.....	28
7.4.1	M 20 Drive-in Electrode.....	29
7.4.2	M 20-HW 200/300 Stick-in Electrode Pair.....	29
7.4.3	M 20-OF 15 Surface Measuring Caps.....	30
7.4.4	M 20-DS 16 and M 20-DS 16-i Conversion Kit.....	30
7.4.5	M 19 Stick-in Electrode.....	31
7.4.6	M 18 Ram-in Electrode.....	31
8	Accessories.....	33
9	Appendix.....	36
9.1	Material Table.....	36
9.2	Wood Moisture Equilibrium Table.....	36
9.3	Wood Temperature Compensation Table.....	37
9.4	General Concluding Remarks.....	38
10	EU Declaration of Conformity.....	39

1 Foreword

1.1 User Description

These instructions are intended for the end user of the product. The end user of the product is a person who has read and understood these operating instructions, is an experienced user of similar devices and is aware of all possible dangers and can act accordingly.

The device may only be used by persons aged 14 and over who have read and understood these operating instructions, are familiar with the operation of similar products and are aware of all possible dangers and act accordingly.

The device is intended for use by persons who have experience with moisture measurements (structural moisture, wood moisture, climate, etc.).

All personnel involved in the operation, installation, inspection and maintenance of the product must be qualified to carry out the associated work. If the personnel concerned do not already have the required knowledge and skills, appropriate training and instruction must be ensured.

All local regulations must be observed.

1.2 Intended Use

The Hydromette BL H 40 is an electronic wood moisture meter for precisely measuring sawn timber, chipboards and veneers.

The device has a wood type selector function for automatic correction of measured values for over 300 types of wood as well as manually adjustable wood temperature compensation.

Various electrodes are available for measurement. The measuring pins of the electrodes are pressed or driven into the respective material to be measured and thus enable the detection of moisture in sawn timber (up to max. 180 mm thick), chipboard, veneers and wood fibre materials.

The Hydromette BL H 40 may only be used for moisture measurements in wood.

1.3 Non-Intended Use





The device is not intended for any applications that are not listed in these operating instructions.

The device, accessories, tools, software, etc. must be used in accordance with these instructions, taking into account the working conditions and the work to be performed. Using the product for work other than that for which it is intended will result in a hazardous situation.

The device may only be used together with the original accessories. The device must only be used within the specified performance limits as described in these instructions.

1.4 Explanation of the General Warnings

The following danger levels are used in this operating manual to indicate potentially dangerous situations and important safety instructions:

Danger Level	Description
 DANGER	Danger / Indicates a hazardous situation which, if not avoided, will result in death or serious irreversible injuries.
 WARNING	Warning / Indicates a hazardous situation which, if not avoided, could result in death or serious irreversible injuries.
 CAUTION	Caution / Indicates a hazardous situation which, if not avoided, could result in minor or moderate injuries.
 INFORMATION	Indicates important information.

1.5 General Safety Instructions

It must be ensured that the complete instructions and all safety instructions have been read and understood before using this device.

All instructions must be followed. This prevents accidents that can result in property damage or minor or moderate injuries.



All safety information and instructions must be kept for future reference and passed on to subsequent users of the product.

INFORMATION

The manufacturer shall not be liable for any damage to property or injuries to persons that can be attributed to incorrect handling or non-compliance with the safety instructions. In such cases, the warranty shall be void.

1.5.1 Persons at Risk

Persons with reduced physical, sensory or mental capabilities or lack of experience and knowledge must be supervised or instructed in the safe use of the device and understand the associated hazards.

Children must be supervised to ensure that they do not play with the device. The device is not a toy. There is a risk of swallowing small parts of the device (e.g. battery compartment cover) or an accessory (e.g. TF-Stick, not for all BL device types).

This device is not intended for use by persons with reduced physical, sensory or intellectual capabilities, or lack of experience and/or knowledge.



WARNING

Risk of suffocation, injury or permanent disability. The device must not be used by persons under the age of 14!

Risk of suffocation! Keep packaging away from children.

1.5.2 Preparation and Start-up

Never store or place the device in a location where it can fall or be drawn into water or other liquids.

To avoid the risk of electric shock, never immerse the device in water or other liquids.

Always remove all packaging before operating the device.



WARNING

Fire hazard!
Do not use a damaged device.

In the event of visible damage, strong odours or excessive heating of components, the battery must be removed immediately and the appliance must not continue to be used.

1.5.3 Use / Operation



CAUTION

Risk of damage. The device is a highly sensitive measuring instrument.
Only use the device in a controlled electromagnetic environment.

Do not let the device drop onto hard surfaces. This can result in malfunctions or functional failures. Normal use of the device, without excluding hazards to the user, cannot be guaranteed.

The device is fragile.

To avoid overheating, the device must not be covered or used near heat sources or direct sunlight and only be used at ambient temperatures between 0 °C and 40 °C.

The device may not be stored or operated in aggressive atmospheres or atmospheres containing solvents!

The measuring device may be operated in residential and commercial areas.

Measurements **must not** be carried out on conductive surfaces.

Static charge - At low humidity levels, static electricity with high voltage can build up, favoured by external circumstances (friction during material transport, high insulation value of the surrounding area), which can lead to strong fluctuations in measured values. Even the instrument operator may - inadvertently - contribute to the build-up of a static charge by the clothing worn. A considerable improvement can be achieved by the operator and the measuring instrument being absolutely still during measuring, as well as by earthing (contact with conducting metal, water or heating pipes, etc.).

1.5.4 Care, Maintenance and Inspection



CAUTION

Remove the battery before cleaning the product. Do not use abrasive cleaning cloths or chemicals to clean the product as these can damage the surface.

Stop using the product in the case of visible damage, strong odour development or excessive overheating of components.

Only use original accessories.

Changes to the device and technical modifications are not permitted without the written consent of the manufacturer.

All connection options and the device itself must not be sprayed directly or indirectly with water when cleaning (connections depend on the device! e.g. BNC-, 2.5 mm, 3.5 mm jack receptacle and mini-USB port).

Our recommendation: To ensure functionality, have all your measuring equipment checked by the manufacturer every 2–3 years (depending on the frequency of use).

1.5.5 Troubleshooting

Do not repair the device yourself. Contact the manufacturer if the device is not functioning properly.

1.5.6 Disposal

Electrical equipment, accessories and packaging must not be disposed of together with household waste (only for EU countries) and must be disposed of in compliance with the European Directive 2012/19/EU on waste electrical and electronic equipment and its implementation in accordance with national law. Electrical equipment that has reached the end of its service life must be collected separately and sent to an environmentally compatible recycling facility.

The WEEE symbol draws attention to the need for disposal.

The device contains a battery. Batteries must not be disposed of with normal household waste. They may contain toxic heavy metals and are subject to the hazardous waste ordinance. For this reason, dispose of the battery at a local collection point for the recycling of waste electrical and electronic equipment. Caution, there is a risk of explosion if the wrong type of battery is inserted. Handle used batteries according to the manufacturer's instructions.

Gann Mess- u. Regeltechnik GmbH accepts no liability for damage caused by non-compliance with the operating instructions or by violation of a duty to care during transport, storage or operation of the instrument, even if this duty to care is not specifically discussed in the operating instructions.

1.6 Specific Warnings



CAUTION

There is a risk of injury from the measuring pins of the electrodes for resistance measurement. There is also a risk of injury due to careless handling when piercing / knocking into the material to be measured. Before the electrode pins are pressed / driven into walls or ceilings (e.g. wooden panels or similar), it is essential to ensure by suitable means that there are no electrical cables, water pipes or other supply lines in this location.

2 Specifications

2.1 Technical Data

Hydromette

Display:	LCD segment display with three lines
Display resolution:	0.1 % for humidity
Response time:	< 2 s
Storage conditions:	+ 5 to + 40 °C - 10 to + 60 °C (for a short time)
Operating conditions:	0 to + 50 °C - 10 to + 60 °C (for a short time) < 85 % R.H. non-condensing
Power supply:	9-V-block battery
Types that can be used:	Types 6LR61 and Type 6F22
Dimensions:	185 x 50 x 30 (L x W x H) mm
Weight:	approx. 170 g
Protection class:	III
Protection rating:	IP20

2.2 Prohibited Environmental Conditions

- Condensation. humidity continuously too high (> 85% R.H.) and wetness
- Permanent presence of dust and combustible gases. vapours or solvents
- Ambient temperatures continuously too high (> +50 °C)
- Ambient temperatures continuously too low (< 0 °C)

2.3 Transport- & Storage Conditions

The Hydromette BL Compact may **only be stored in the packaging provided by the manufacturer or available from the manufacturer as an accessory**. The manufacturer shall not accept any liability or warranty for damage that may occur to the device or to the sensor system as a result of non-compliance.



INFORMATION

In particular, **avoid keeping or storing the devices in foams not supplied by the manufacturer**, as these can damage the sensors due to possible outgassing and result in incorrect measurements.

2.4 Measuring Range

Wood moisture:	5 to 40 % 7-level wood species correction
Compensation temperature:	Manual compensation in steps of 1 °C: Adjustable in the range from -10 °C to 40 °C

3 General Information

3.1 Standards and Directives

This measuring instrument fulfils the requirements of the applicable European and national directives (2014/30/EU) and standards (EN 61010). Appropriate declarations and documentation are held by the manufacturer.

To ensure trouble-free operation of the measuring instrument and operational reliability, the user must carefully read and understand the operating instructions.

3.2 Warranty

The measuring instrument may only be operated under the specified climatic conditions. These are listed in [chapter 2.1 "Technical Data](#) of the Hydromette".

This measuring instrument may only be used under the conditions and for the purposes that it has been designed for. Operational reliability and functionality are no longer ensured if the device is modified or adapted. Gann Mess- u. Regeltechnik GmbH shall not be liable for any damage arising from such modifications or adaptations. The risk is borne solely by the user.

The measuring instrument and any accessories may only be properly used as described in these instructions. Keep the device and accessories out of the reach of children!

The device must not be stored or operated in air that is corrosive or contains solvents!

The notes and tables in these instructions regarding permitted or normal humidity conditions in practice and the general definitions of terms have been taken from the specialist literature. Therefore, the manufacturer cannot guarantee the correctness. The conclusions to be drawn from the measurement results depend for each user on the individual circumstances and the knowledge gained from his professional experience.

The measuring instrument may be used in the residential and commercial sectors.

The measuring instrument may only be stored in the packaging provided by the manufacturer or available from the manufacturer as an accessory. The manufacturer accepts no liability for damage that may occur to the device or the sensor system as a result of non-compliance.

Gann Mess- u. Regeltechnik GmbH accepts no liability whatsoever for damage caused by non-compliance with the operating instructions or by breach of the duty of care during transport, storage and handling when operating the device, even if this duty of care is not specifically referred to in the operating instructions.

4 Description of the Product

The Hydromette BL H 40 is an electronic moisture meter for precision measurements of sawn timber, chipboard and veneer with a high-quality measuring amplifier.

The device has a wood type selector function for automatic correction of measured values for over 300 types of wood as well as manually adjustable wood temperature compensation.

Various electrodes are available for measurement. The measuring pins of the electrodes are pressed or driven into the respective material to be measured and thus enable the detection of moisture in sawn timber (up to max. 180 mm thick), chipboard, veneers and wood fibre materials.

The characteristic curves stored in the device for the 7-level wood type correction allow the measured values to be displayed directly in per cent by weight (wt.-%).

An internal memory is available for storing data.

5 Device Layout and Button Assignment



Figure 5-1: View of the Hydromette BL H 40

5.1 Display Symbols

5.1.1 Main Menu Symbols

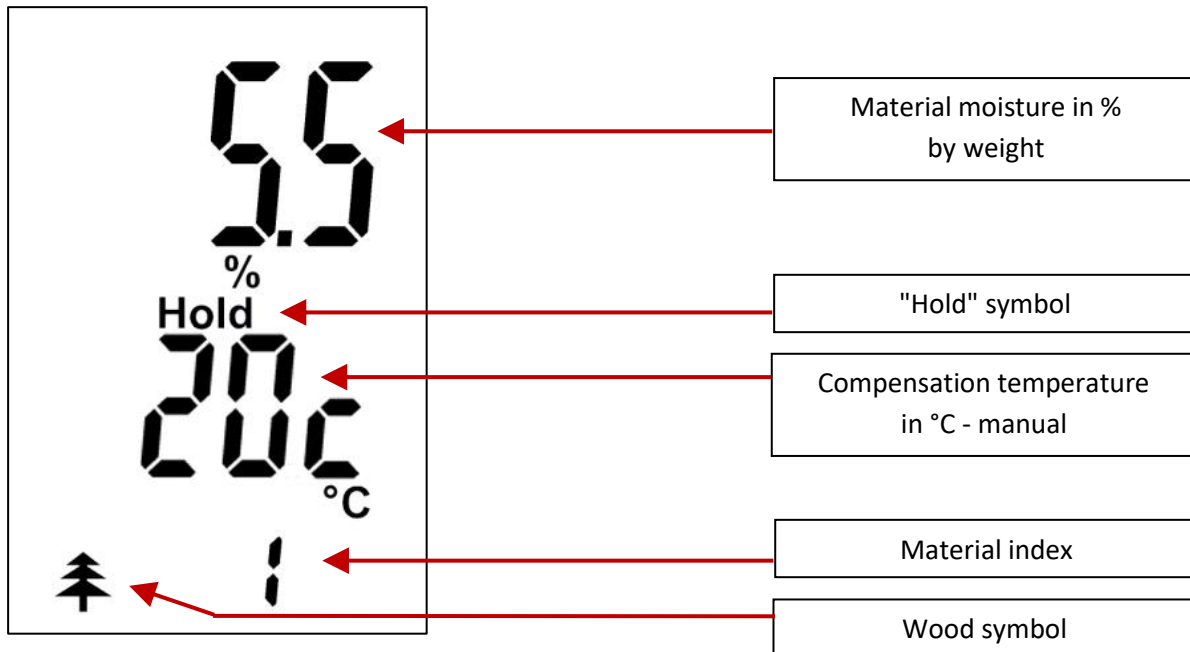

Figure 5-2: Main menu symbols

5.1.2 Other Symbols

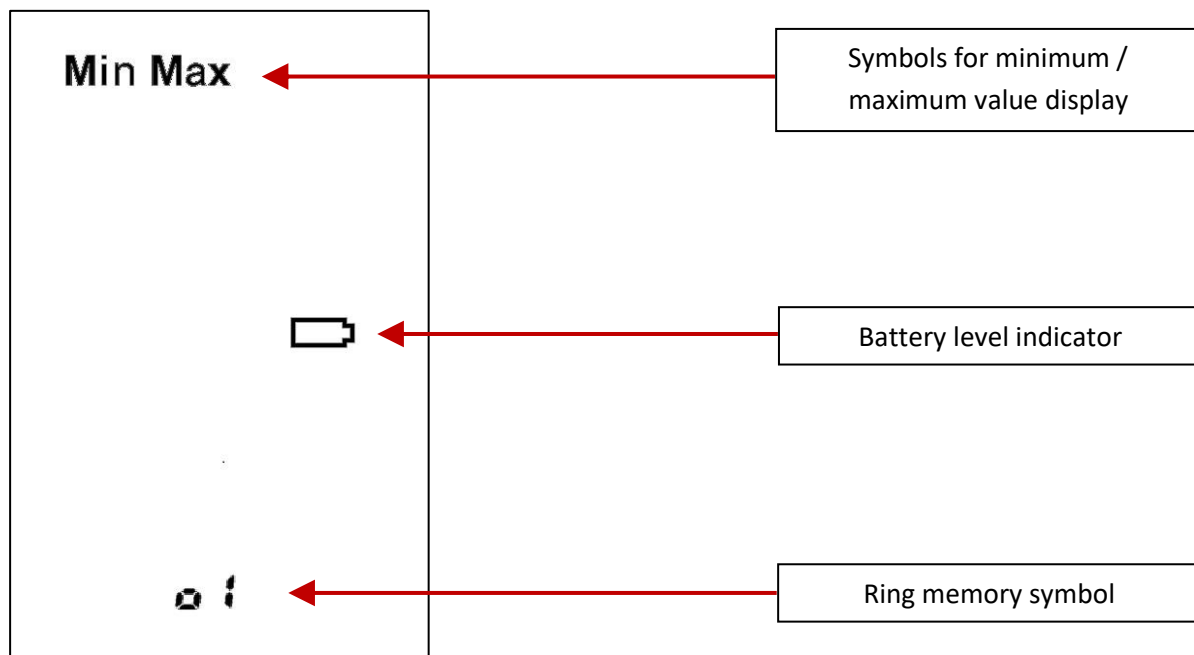



Figure 5-3: Other symbols

5.2 Switching the Device On and Off

The device is switched on and off by pressing the "On / Off" button . The device starts in the measuring menu or main menu. The measuring process can be carried out here [[see Chapter 5.3.1 "Measurement menu \(main menu\)"](#)].

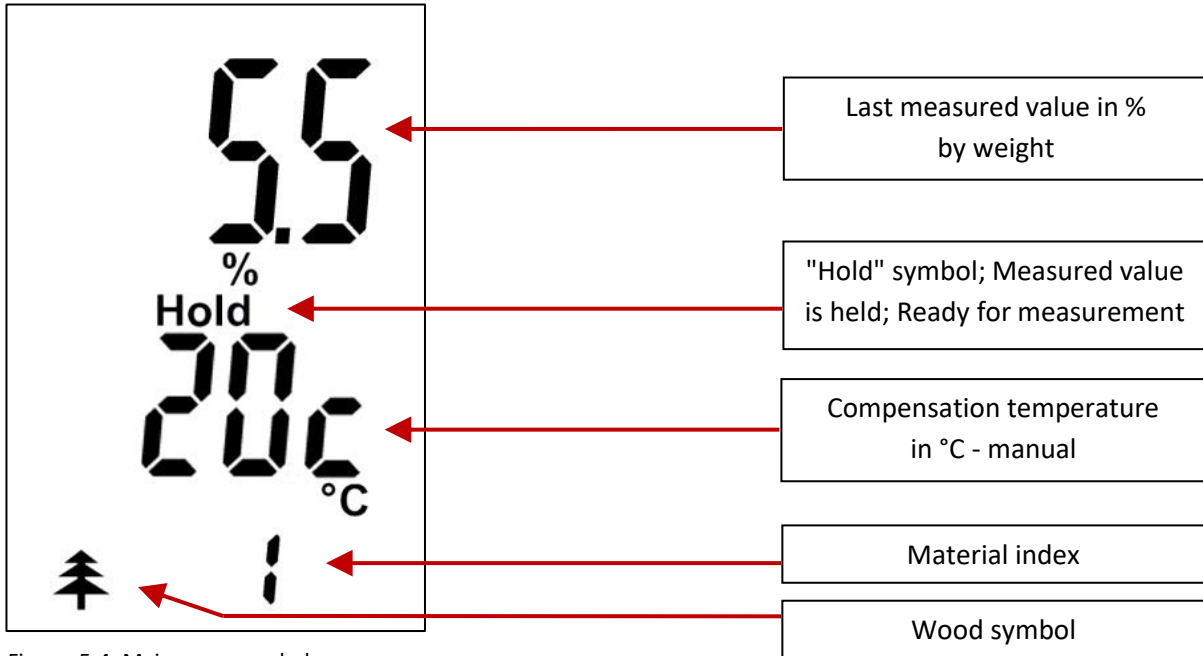

Figure 5-4: Main menu symbols

5.3 Setting Menus

The following menu items can be selected one after the other by repeatedly pressing the "Down" button:

1. **Measuring Menu** (main menu): The measuring process can be performed here.
2. **Material setting**: The wood type can be selected here.
3. **Compensation temperature**: The compensation temperature can be set here.
4. **Maximum value display**: The largest measured value is shown here.
5. **Minimum value display**: The smallest measured value is shown here.
6. **Memory Menu**: The last 5 measured values are stored here. The oldest value is overwritten after each measurement.

The menu items are selected in reverse order by pressing the "Up" button.

5.3.1 Measuring Menu (Main Menu)

After switching on, the device is in the measuring menu (main menu). The other menus can be accessed from here by pressing the "**Up**" or "**Down**" buttons.

In the measuring menu, the last measured values are displayed according to the material selection made with the associated units and the note "**Hold**".

Measurements are taken by pressing / driving the measuring pins into the material to be measured. A new measurement is started by pressing the "**M**" button (*> 2 seconds*).

During the measuring process, the "**Hold**" symbol disappears from the display. After releasing the "**M**" button, the measured value is held and automatically stored in the ring memory. This overwrites the oldest stored value. The "**Hold**" symbol is displayed again.

If the new measured value is larger than the previous maximum value, "**Max**" flashes on the display. If the new value should be accepted, the "**M**" button must be pressed *briefly (< 1 second)*. If the value should not be saved, a new measurement can be started by pressing and holding (*> 2 seconds*) the "**M**" button without changing the previous maximum value.

If the new measured value is smaller than the previous minimum value, "**Min**" flashes on the display. If the new value should be accepted, the "**M**" button must be pressed *briefly (< 1 second)*. If the value should not be saved, a new measurement can be started by pressing and holding (*> 2 seconds*) the "**M**" button without changing the previous minimum value.

If the measuring range of a selected material is exceeded or not reached, a flashing measured value warns you, which is also marked alternately with "**LO**" or "**HI**".

5.3.2 Material Setting

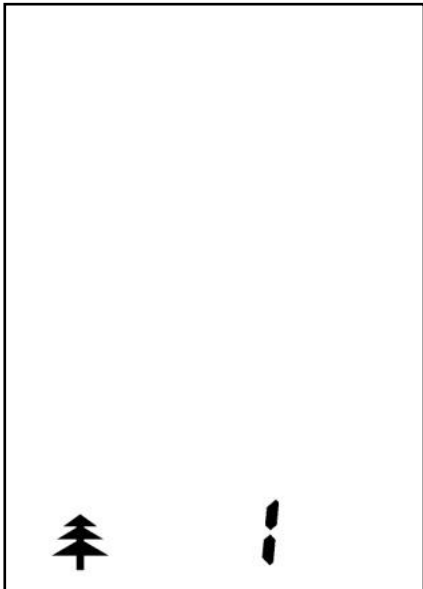

Figure 5-5: Material selection

The set material code index and the symbol for wood moisture are displayed.

To be able to make the material settings, the device must be switched on and in main measuring mode. Then press the "Down" button once to access the material settings. If you now want to change the setting for the material, press the "M" button *briefly* (< 1 second).

The measuring mode display flashes and can be set using the "Up" and "Down" buttons. The change is saved by *briefly* (< 1 second) pressing the "M" button again.

After confirming the change, the display automatically jumps to the measuring menu of the (newly) selected material. This removes the values of the previous measuring mode from the display. Any stored "Max" or "Min" values remain in the memory of the respective material.

Now a new measurement can be performed by pressing and holding (> 2 seconds) the "M" button.

The Hydromette BL H 40 has a 7-level wood type correction. The setting for the wood to be measured is therefore taken from the "1..7" column.

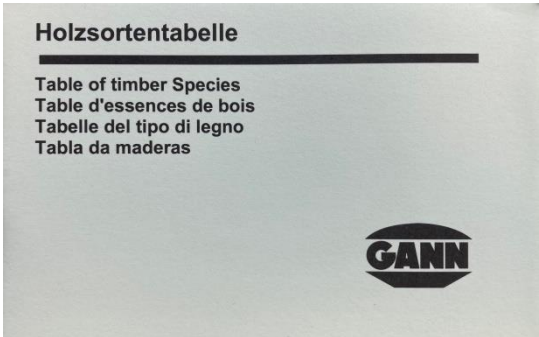

Figure 5-6: Front of wood type table

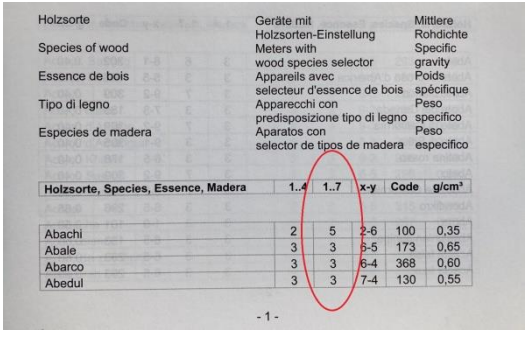

Figure 5-7: Using the wood type table

A wood type table is enclosed with the instrument on delivery.

5.3.3 Compensation Temperature



The Hydromette has an automatic compensation of the measured value depending on the adjustable material temperature. This measured value compensation is always carried out with the temperature displayed in the measuring mode. The instrument is supplied as standard with a compensation temperature of 20 °C as the factory setting.

Setting the user-defined compensation temperature:

The user-defined compensation temperature is shown with a "c" next to the temperature display.



Figure 5-8 User-defined compensation temperature

To be able to set the temperature, the instrument must be switched on and in main measuring mode. Then press the "**Down**" button twice to access the compensation temperature. If you now want to change the setting for the compensation temperature, press the "**M**" button *briefly* (< 1 second).

The temperature display flashes and can be set in increments of 1 °C using the "**Up**" and "**Down**" buttons. The value is changed in steps of five by pressing and holding the "**Up**" or "**Down**" button. The material temperature can be set in the range between -10 °C and 40 °C.

The change is saved by *briefly* (< 1 second) pressing the "**M**" button again. After confirming the change, the display automatically jumps to the measuring menu.

Now a new measurement can be performed by pressing and holding (> 2 seconds) the "**M**" button.

5.3.4 Maximum Value Display

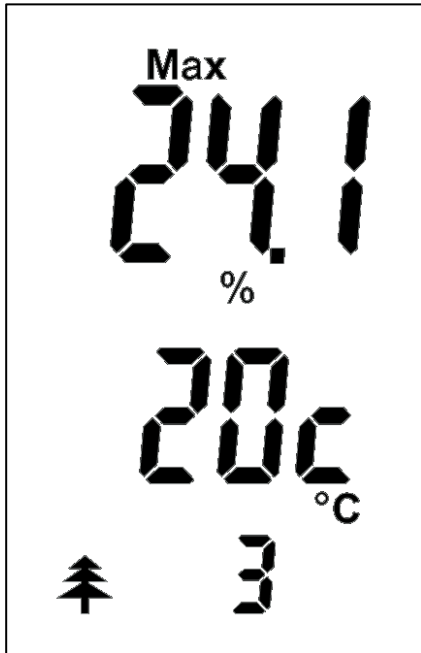

Figure 5-9: Maximum value display

The highest measured value of a measurement series is displayed together with the "Max" display symbol.

A dash at the position of the measured value indicates that there is no maximum value (yet).

If an existing maximum value should be deleted, the displayed value must be selected by *briefly* (< 1 second) pressing the "M" button.

The value flashes and can now be deleted by pressing and holding (> 1 second) the "M" button. A dash at the position of the measured value indicates the successful deletion of the value.

The device returns to the measuring mode by *briefly* (< 1 second) pressing the "M" button again.

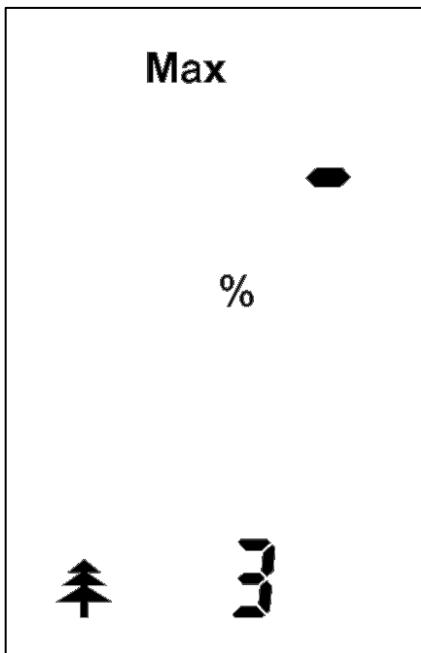

Figure 5-10: Deleted maximum value

A new measurement can then be performed immediately by pressing and *holding* (> 2 seconds) the "M" button.

5.3.5 Minimum Value Display

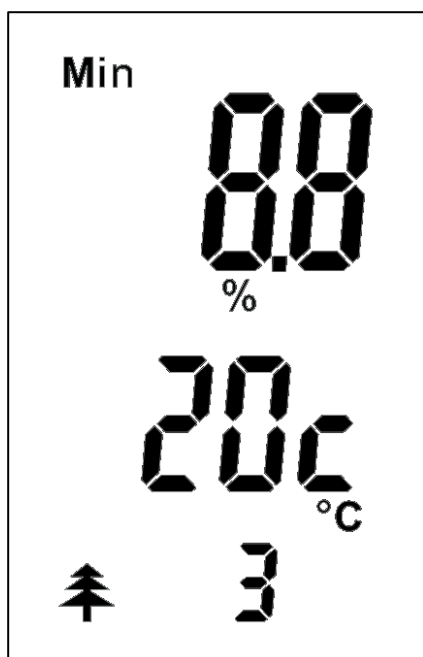

Figure 5-11: Minimum value display

The lowest measured value of a measurement series is displayed together with the **"Min"** display symbol.

A dash at the position of the measured value indicates that there is no minimum value (yet).

If an existing minimum value should be deleted, the displayed value must be selected by *briefly* (< 1 second) pressing the **"M"** button.

The value flashes and can now be deleted by pressing and holding (> 1 second) the **"M"** button. A dash at the position of the measured value indicates the successful deletion of the value.

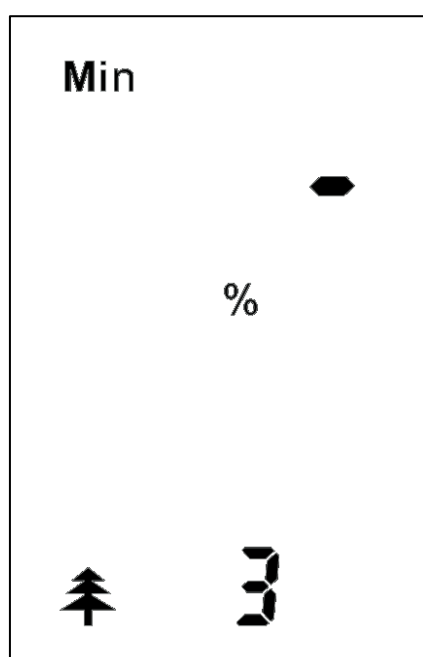

Figure 5-12: Deleted minimum value

The device returns to the measuring mode by *briefly* (< 1 second) pressing the **"M"** button again.

A new measurement can then be performed immediately by pressing and *holding* (> 2 seconds) the **"M"** button.

5.3.6 Memory Menu

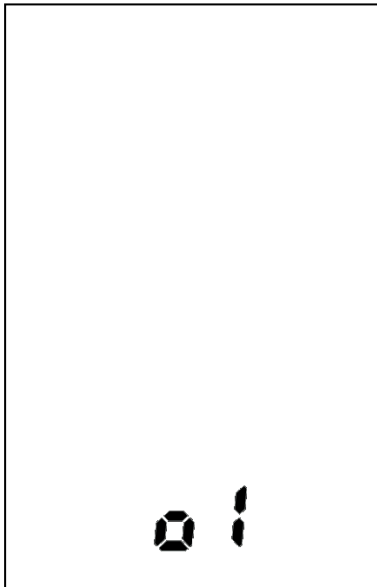

Figure 5-13: Memory location "o1"

As soon as you select the memory menu, the memory location number "o1" is displayed for approx. 1 second, and then the last measured saved value contained there is displayed.

By *briefly* (< 1 second) pressing the "M" button, the next memory location "o2" can be selected and the value it contains displayed.

The last 5 measured values are automatically saved and stored in the memory locations "o1" – "o5". The last measured value is in memory location "o1". The memory is designed as a ring memory. As soon as a sixth measured value is recorded, the oldest measured value in memory location "o5" is automatically removed from the memory.

After reaching the 5th memory location, the value of the 1st memory location is displayed again. Manual deletion of a memory value is not possible.

If the "M" button is pressed (and held) for *longer than 2 seconds*, the display of the memory value vanishes, only the memory location number is displayed. This signals that the user is still in the Memory Menu and not in the Measuring Menu. The memory value is retained in the background.

The saved values displayed can be identified by the fact that there is **no "Hold" symbol** in the display.

6 Other Functions

6.1 Automatic Switch-Off

If no button is pressed within approx. 90 seconds, the device switches off automatically. The current values are retained and are displayed again after the device is switched on again.

6.2 Battery Monitoring

If the battery symbol  is shown in the display, the battery is dead and must be replaced. A list of battery types that can be used can be found in chapter "[2.1 Technical Data](#)".

The device serial number is also located in the battery compartment.

6.3 Querying the Device Firmware

To query the firmware version of the device, the "Down" button (∇) and the "Up" button (Δ) must be pressed simultaneously for approx. 2 seconds when the device is switched on. A "V" appears in the first line of the display, the firmware version number in the second line and a specific ID number (device-dependent) in the third line.

Briefly press the "M" button to return to measuring mode.

7 Application Notes

7.1 Comparative Measurement or Reference Measurement

With this type of measurement, almost all (set) building materials or mixed materials or mixed structures can be measured comparatively. It is important that these measurements are only carried out on the same materials or structures.

A deliberately dry spot must be determined on the structure to be measured. Select up to 5 measuring points within an imaginary square with a side length of approx. 20 cm. A dry sample of material with minimum dimensions of 20x20x5 cm can also be used as a reference. When measuring using a sample piece, it is important that this measurement is carried out on a non-conductive surface (e.g. polystyrene). The mean value is now to be calculated from these up to 5 measured values. This forms the reference value for the dry condition of the material or structure. Larger areas can thus be analysed using increased display values, e.g. with regard to the maximum moisture or the extent of moisture damage, and a two-dimensional moisture profile can be created. Drying progress can also be checked and observed by repeating measurements at defined measuring points.

When assessing the display values using the **capacitive measuring method**, it should be noted that metal in the substrate (iron armouring, cables, pipes, plaster rails, etc.) can lead to an increase in the measured value depending on the overlap height. Furthermore, it must be ensured that the minimum distances of 8–10 cm to corners, angles and edges are observed. Measurements in drilled holes or mortises are always incorrect measurements and cannot be used for assessment. Please note that digit measurements taken with devices with a measuring range of 0–100 digits and devices with a measuring range of 0–200 digits are not comparable.

When assessing the display values using the **resistance-based measuring method**, it is essential that you use suitable means to ensure that there are **no** electrical cables, water pipes or other supply lines in this location **before** drilling holes for probes or before knocking electrode pins into walls, ceilings, floors, etc.



INFORMATION

Digit readings obtained using the resistance-based measurement methods are not comparable with digit readings obtained using the capacitive measurement method.

Digit values are non-dimensional measured values and no real humidity values in per cent (%)! For this reason, the measured values are displayed in digits WITHOUT %!

7.2 General Information on Wood Moisture Measurement

The wood moisture in the GANN Hydromettes® is displayed in per cent by weight (wt.-%) in relation to absolutely dry wood (bone-dry).

If wood is stored for extended periods in a given climate it assumes a moisture content corresponding to this climate, which is also termed equilibrium moisture or **wood moisture equilibrium**. When the equilibrium moisture is reached the wood does not give off or absorb any further moisture for constant ambient climatic conditions. The [wood moisture equilibrium](#) in the winter months is approx. 6.0% to 7.5% wood moisture (corresponds to 30–40% rel. humidity and 20–25 °C) and in the summer months approx. 10.5% to 13.0% (corresponds to 60–70% rel. humidity and 25 °C).

Wood shrinks when it gives off moisture to the surrounding air below the fibre saturation range. In contrast, wood swells when it absorbs moisture from the surrounding air below the fibre saturation range.

7.3 Notes on resistance-based Measuring Wood Moisture

The GANN Hydromettes works by measuring electrical resistance or conductivity, a principle which has been well-known for many years. This process is based on the fact that electrical resistance is highly dependent on the amount of moisture in the wood. The conductivity of oven-dried wood is very low, or the resistance is so high that no current worth mentioning can flow. The more water that is present, the greater the conductivity of the wood, or the lower the electrical resistance.

Above the fibre saturation point (from approx. 30 % wood moisture), the measurement loses accuracy as the wood moisture increase, depending on the type of wood, bulk density and wood temperature. At low wood moisture levels below 10 % or at low air humidity levels, **static electricity** with high voltage can build up, favoured by external circumstances (friction during material transport, high insulation value of the surrounding area), which can lead to strong fluctuations in measured values. The operator of the measuring instrument can also unintentionally contribute to the build-up of static charge from the users clothing. A significant improvement can be achieved by ensuring the operator and the measuring instrument remain completely still during the measuring process and by earthing (by touching conducting metal, water or heating pipes, etc.).

In order to achieve the qualitatively best possible measurement results, the wood used for the sample should be measured at multiple points. For this purpose, the electrode pins must be pressed or hammered in at right angles to the fibre direction up to at least 1/4 and at most 1/3 of the total wood thickness. To avoid measurement errors and the risk of the measuring pins breaking, the fastenings of the electrode pins must always be tightened properly and the area between the pin holders must be kept clean.

With uninsulated pins, the measured value is formed at the wettest point (the driven in / pressed-in electrode pins). If the moisture distribution in the wood is homogeneous, this means measuring the entire depth between the driven in / pressed-in pins.

Please note that:

In order to determine any increased core moisture, the electrode pins must be driven in approx. 1/3 of the entire wood thickness.

- Particularly in the case of moisture ingress from outside. e.g. rain or condensation, only the increased surface moisture is measured, regardless of the penetration depth.

The **temperature of the wood to be measured** has a major impact on the electrical wood moisture measurement. The electrical resistance of wood changes not only with the water content, but also with the temperature. Assuming a constant water content, the resistance decreases with increasing temperature, whereas decreasing temperature results in an increase. This temperature dependence is not constant but increases with increasing wood moisture. It is not possible to measure frozen wood above 20 % moisture content.

Simple wood moisture measuring instruments are generally designed for a wood temperature of 20°C, so that if there are deviations from this temperature value, the display no longer corresponds to the actual wood moisture. At temperatures < 20 °C the wood moisture values displayed are too low, at temperatures > 20 °C they are too high. It is therefore necessary to correct the values obtained using an appropriate correction table. Various GANN Hydromettes® are already equipped with such temperature compensation, i.e. the wood temperature can be set directly on the measuring instrument and is automatically taken into account in the wood moisture display. For measuring instruments that do not have such **temperature compensation**, you can roughly calculate a measured value deviation of approx. 1 % wood moisture for every 10 °C deviation from 20 °C, provided the wood is dry. In addition, the GANN Hydromettes® have a wood temperature compensation table in the appendix of the operating instructions.

7.3.1 Test Adapter for resistance-based Wood Moisture Measurement

The test adapter for checking the wood moisture measuring section, available under order no. 31006070, can be used to check the functionality of the device and any existing accessories such as the MK 8 measuring cable or the M 18, M 19 and M 20 electrodes.

Depending on the device used, the measuring pins of the instrument must be held directly to the sockets of the test adapter or the device must be connected to the MK 8 measuring cable and the 4mm plugs of the cable plugged into the sockets of the test adapter. If an electrode is also to be tested, connect the cable to the electrode and hold the pins of the electrode to the sockets of the test adapter.

Select the (material) setting on the measuring instrument that corresponds to the imprint on the test adapter or the description in the operating instructions for the test adapter. No active sensor may be connected.

7.4 Using the Hydromette BL H 40

When measuring wood moisture, the two measuring pins of the Hydromette must be pushed / hammered into the wood to be measured at right angles to the fibre direction. When removing them, light prying movements can be used at right angles to the grain to loosen the pins. Please refer also to the notes on wood moisture measurement in Sections [7.2](#) and [7.3](#).



Figure 7-1: Wood moisture measurement – perpendicular to direction of fibres



INFORMATION

For a reliable measurement result, the measurement button must be pressed for at least two seconds. If the material is very dry, the measuring button must be pressed for up to eight seconds.

7.4.1 M 20 Drive-in Electrode

The M 20 drive-in electrode is made of impact-resistant plastic and is suitable for measuring wood thicknesses of up to 50 mm. When the drive-in electrode M 20 is first delivered, 10 replacement pins of 16 and 23 mm length are included in the delivery.

The two electrode pins of the drive-in electrode must be pressed or hammered into the wood to be measured at right angles to the fibre direction. When removing them, light prying movements can be used at right angles to the grain to loosen the pins.

To change the electrode pins, the coupling nut must be unscrewed. The pins can then be simply replaced. Where possible, the coupling nuts should be tightened before beginning a measurement using a spanner (WAF 12) or pliers. Loose electrode pins tend to break more easily and cause unstable measured values.

If thicker wood is to be measured, the electrode pins can be replaced with a suitably longer version. With increasing tip length, however, increased danger of breakage or bending (particularly when pulling out) must be expected. It is therefore recommended to use the M 18 ram-in electrode for thicker or particularly hard woods.

With uninsulated pins, the measured value is formed at the wettest point (the driven in electrode pins). If the moisture distribution in the wood is homogeneous, this means measuring the entire depth between the driven-in pins.

Please note that:



INFORMATION

- In order to determine any increased core moisture, the electrode pins must be driven in approx. 1/3 of the entire wood thickness.
- Particularly in the case of moisture ingress from outside, e.g. rain or condensation, only the increased surface moisture is measured, regardless of the penetration depth.

7.4.2 M 20-HW 200/300 Stick-in Electrode Pair

If the hex nuts with standard electrode pins on the M 20 electrode are removed, they can be replaced with the M 20-HW electrode pins. These must be fastened tightly!

For measurements in shavings and wood wool, it is advisable to compact the material to be measured a little. To do so, wood shavings should be pressed together with a weight of approx. 5 kg. No compression is necessary for balls of wood wool.

7.4.3 M 20-OF 15 Surface Measuring Caps

The surface measuring cap pair M 20-OF 15 is used in conjunction with the M 20 electrode for resistance-based measurement of moisture on surfaces without damaging the material being measured. In the area of wood moisture, it can be used to measure workpieces that have already been processed or to measure veneers or multi-layer parquet / multi-layer planks. Before measuring, the two hexagon nuts on the M 20 electrode must be unscrewed and replaced with the surface measuring caps. For measurement, the two contact surfaces must be pressed onto the workpiece to be measured at right angles to the fibre direction. It is important to ensure that the elastic transducers are pressed firmly onto the surface but that the metal holders do NOT touch the material to be measured (contact pressure approx. 3 kg). The measuring depth is approx. 2–5 mm, therefore several veneer layers must be placed on top of each other, especially when measuring veneers.

Surface measurements should only be made with wood moisture levels under 30 %!

When measuring stacks of veneer, to expose the measuring point, the veneer is lifted and not pulled over the remaining stack (avoid friction: electrostatic charge!).

Any wood particles adhering to the measuring surface must be regularly removed. If the elastic, plastic measurement sensors are damaged, they can be reordered (no. 31004316) and glued on using standard cyanate-based instant adhesive.

7.4.4 M 20-DS 16 and M 20-DS 16-i Conversion Kit

The M 20-DS 16 conversion kit is used to measure the moisture content of wood up to 30 mm thick. The particularly thin pins (1.6 mm [Ø]) leave barely visible puncture marks in the material (e.g. skirting boards or veneers).

The M 20-DS 16-i conversion kit reduces the impact of surface moisture during measurement. If other electrode nuts are used, the measured values can be falsified by surface contact (e.g. the measuring pins are driven in too deeply). The insulated electrode nuts are also very suitable for measuring wood fibre insulation boards.

To use a conversion kit, first unscrew the coupling nuts of the electrode with standard electrode pins. The hexagon nuts and matching pins can then be easily replaced. Where possible, the coupling nuts should be tightened before beginning a measurement using a spanner (WAF 12) or pliers. Loose electrode pins tend to break more easily and cause unstable measured values.

7.4.5 M 19 Stick-in Electrode

The stick-in electrode M 19 is made of impact-resistant plastic and is suitable for measuring finished thermal insulation composite systems (e.g. wood fibre insulation materials). The initial delivery of the stick-in electrode M 19 includes 10 Teflon-insulated electrode pins, each 60 mm long.

To change the electrode pins, the coupling nut must be unscrewed. The pins can then be simply replaced. Where possible, the coupling nuts should be tightened before beginning a measurement using a spanner (WAF 12) or pliers. Loose electrode pins tend to break more easily and cause unstable measured values.

The stick-in electrode M 19 can be pushed through the plaster into the external thermal insulation composite system (using a hammer if necessary). To protect the Teflon coating, you can also pre-drill with a drill bit (2.5 mm [Ø]) if necessary.



Do not completely drive in the electrode pins! To rule out the effects of surface moisture and avoid measurement errors, there should be a gap of at least 1–2 mm between the plaster surface and the hexagon nut.

INFORMATION

The electrode support made of special plastic can be reordered as a spare part (order no. 31003509).

7.4.6 M 18 Ram-in Electrode

The ram-in electrode M 18 is made of corrosion-resistant V2A steel and is suitable for (depth) measurements in up to 180 mm thick or hard wood, wood fibre insulation materials and wood composites. When first delivered, the ram-in electrode M 18 is supplied with 10 replacement pins of 40 and 60 mm length (not insulated).

The two electrode pins of the ram-in electrode must be driven to the required measuring depth crosswise to the grain direction with a slide hammer. Pulling out the electrode pins is also done with the slide hammer with the impact direction upwards.

To change the electrode pins, the coupling nut must be unscrewed. The pins can then be simply replaced. Where possible, the coupling nuts should be tightened before beginning a measurement using a spanner (WAF 12) or pliers. Loose electrode pins tend to break more easily and cause unstable measured values.

With uninsulated pins, the measured value is formed at the wettest point (the driven in electrode pins). If the moisture distribution in the wood is homogeneous, this means measuring the entire depth between the driven-in pins.

Please note that:



INFORMATION

- In order to determine any increased core moisture, the electrode pins must be driven in approx. 1/3 of the entire wood thickness.
- Particularly in the case of moisture ingress from outside, e.g. rain or condensation, only the increased surface moisture is measured, regardless of the penetration depth.

Teflon-insulated electrode pins in lengths of 45 mm (order no. 31004550) or 60 mm (order no. 31004500) are available as special accessories for the M 18 ram-in electrode, each containing 10 pieces. These are suitable for measuring wood thicknesses of up to approx. 120 mm and enable precise zone and layer measurements in wood with widely varying moisture distribution (e.g. surface moisture, water pockets).



INFORMATION

Do not completely drive in the electrode pins! To rule out the effects of surface moisture and avoid measurement errors, there should be a gap of at least 1–2 mm between the wood surface and the hexagon nut.

The electrode support made of special plastic can be reordered as a spare part (order no. 31003509).

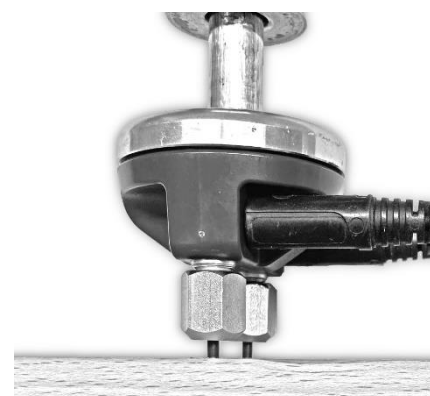

Figure 7-2: Use of Teflon-insulated pins

8 Accessories



Wood moisture test adapter (order no. 31006070)

Test adapter for wood moisture, for check of wood moisture measuring instruments with accessories.



M 20 drive-in electrode (order no. 31003300)

The drive-in electrode M 20 is made of impact-resistant plastic and is suitable for measuring wood thicknesses of up to 50 mm (e.g. sawn timber, chipboard, wood fibreboard). When the drive-in electrode M 20 is first delivered, 10 replacement pins of 16 and 23 mm length are included in the delivery.

Reorder electrode pins, packaging unit 100 pieces:

- 16 mm long (order no. 31004610) with 10 mm penetration depth
- 23 mm long (order no. 31004620) with 17 mm penetration depth

Reorder cap nut, packaging unit 1 piece:

- order no. 31003510



M 20-HW 200/300 stick-in electrode pair

The stick-in electrode pair is suitable for measuring in chips, wood wool and bulk materials. The stick-in electrodes can only be used in conjunction with the M 20 drive-in electrode.

The electrode pins are available in two lengths:

- length 200 mm x \varnothing 4 mm (order no. 31004350)
- length 300 mm x \varnothing 4 mm (order no. 31004355)

M 20-OF 15 surface measuring caps (order no. 31004315)



The surface measuring cap pair is suitable for moisture measurements on surfaces without damaging the material to be measured in conjunction with the M 20 electrode (e.g. veneers, solid or multi-layer parquet). Depth effect 2–5 mm.

Reorder plastic transducer, packaging unit 4 pieces:

- order no. 31004316

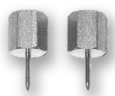

M 20-DS 16 conversion kit (order no. 31004310) and **M 20-DS conversion kit 16-i** (order no. 31004311) in conjunction with drive-in electrode M 20.

The M 20-DS 16 conversion kit is used to measure the moisture content of wood up to 30 mm thick. The particularly thin pins (1.6 mm [Ø]) leave barely visible puncture marks in the material (e.g. skirting boards or veneers).

The M 20-DS 16-i conversion kit reduces the impact of surface moisture during measurement. The insulated electrode nuts are also very suitable for measuring wood fibre insulation boards.



M 19 stick-in electrode (order no. 31003400)

The stick-in electrode M 19 is made of impact-resistant plastic and is suitable for measuring finished thermal insulation composite systems (e.g. wood fibre insulation materials).

The initial delivery of the stick-in electrode M 19 includes 10 Teflon-insulated electrode pins, each 60 mm long.

Reorder electrode pins with insulated stem, packaging unit 10 piece:

- 45 mm long (order no. 31004550) with 25 mm penetration depth

- 60 mm long (order no. 31004500) with 40 mm penetration depth

Reorder cap nut, packaging unit 1 piece:

- order no. 31003510

Reorder electrode holder, packaging unit 1 piece:

- order no. 31003509





M 18 ram-in electrode (order no. 31003500)

The ram-in electrode M 18 is made of corrosion-resistant V2A steel and is suitable for (depth) measurements in up to 180 mm thick or hard wood, wood fibre insulation materials and wood composites.

When first delivered, the ram-in electrode M 18 is supplied with 10 replacement pins of 40 and 60 mm length (not insulated).

Reorder electrode pins (not insulated), packaging unit 100 pieces:

- 40 mm long (order no. 31004640) with 34 mm penetration depth
- 60 mm long (order no. 31004660) with 54 mm penetration depth

Reorder electrode pins with insulated stem, packaging unit 10 pieces:

- 45 mm long (order no. 31004550) with 25 mm penetration depth
- 60 mm long (order no. 31004500) with 40 mm penetration depth



Reorder cap nut, packaging unit 1 piece:

- order no. 31003510

Reorder electrode holder, packaging unit 1 piece:

- order no. 31003509



MK 8 measuring cable - length 1 m (order no. 31006210)

For connection of electrodes for resistance measurement

9 Appendix

9.1 Material Table

- 1 Wood type 1
- 2 Wood type 2
- 3 Wood type 3
- 4 Wood type 4
- 5 Wood type 5
- 6 Wood type 6
- 7 Wood type 7

Display in:

wood moisture in weight % / atro

9.2 Wood Moisture Equilibrium Table

Wood Moisture Equilibrium					
Air temperature in °C					
	10 °C	15 °C	20 °C	25 °C	30 °C
Relative air humidity	Wood moisture content				
20%	4.70%	4.70%	4.60%	4.40%	4.30%
30%	6.30%	6.20%	6.10%	6.00%	5.90%
40%	7.90%	7.80%	7.70%	7.50%	7.50%
50%	9.40%	9.30%	9.20%	9.00%	9.00%
60%	11.10%	11.00%	10.80%	10.60%	10.50%
70%	13.30%	13.20%	13.00%	12.80%	12.60%
80%	16.20%	16.30%	16.00%	15.80%	15.60%
90%	21.20%	21.20%	20.60%	20.30%	20.10%

9.3 Wood Temperature Compensation Table

Wood temperature in °C	Measured values														
		4	5	6	7	8	9	10	11	12	13	14	15	16	17
	-10	7.0	8.5	9.5	11.0	12.0	13.5	14.5	16.0	17.0	18.5	19.5	20.5	22.0	23.0
	- 5	6.5	7.5	9.0	10.0	11.0	12.5	13.5	15.0	16.0	17.5	18.5	19.5	20.5	22.0
	0	6.0	7.0	8.5	9.5	10.5	11.5	13.0	14.0	15.0	16.5	17.5	18.5	19.5	21.0
	+5	5.5	6.5	7.5	8.5	9.5	11.0	12.0	13.0	14.0	15.0	16.5	17.5	18.5	20.0
	+10	5.0	6.0	7.0	8.0	9.0	10.5	11.5	12.0	13.0	14.0	15.5	16.5	17.5	19.0
	+15	4.5	5.5	6.5	7.5	8.5	9.5	10.5	11.5	12.5	13.5	14.5	15.5	16.5	18.0
	+20	4.0	5.0	6.0	7.0	8.0	9.0	10.0	11.0	12.0	13.0	14.0	15.0	16.0	17.0
	+25	3.5	4.5	5.5	6.5	7.5	8.5	9.5	10.5	11.5	12.5	13.5	14.5	15.5	16.5
	+30	3.0	4.0	5.0	6.0	7.0	8.0	9.0	9.5	10.5	11.5	12.5	13.5	14.5	15.5
	+35	2.5	3.5	4.5	5.5	6.5	7.5	8.5	9.0	10.0	11.0	12.0	13.0	14.0	15.0
	+40	2.5	3.5	4.0	5.0	6.0	7.0	7.5	8.5	9.5	10.5	11.5	12.0	13.0	14.0
	+45	2.0	3.0	3.5	4.5	5.5	6.5	7.5	8.0	9.0	10.0	11.0	11.5	12.5	13.0
	+50	2.0	2.5	3.0	4.0	5.0	6.0	7.0	7.5	8.5	9.5	10.5	11.0	12.0	12.5
+55	1.5	2.5	3.0	4.0	5.0	5.5	6.5	7.0	8.0	9.0	9.5	10.5	11.5	12.0	
+60	1.0	2.0	2.5	3.5	4.5	5.0	6.0	6.5	7.5	8.5	9.0	10.0	10.5	11.5	
real wood moisture in %															

Wood temperature in °C	Measured values													
		18	19	20	21	22	23	24	25	26	27	28	29	30
	-10	24.5	25.5	27.0	28.0	29.5	30.5	32.0	33.0	34.5	35.5	36.5	38.0	39.0
	- 5	23.0	24.0	25.5	26.5	28.0	29.0	30.5	31.5	32.5	34.0	35.0	36.0	37.0
	0	22.0	23.0	24.5	25.5	26.5	27.5	29.0	30.0	31.0	32.5	33.5	34.5	35.5
	+5	20.5	21.5	23.0	24.0	25.0	26.0	27.5	28.5	29.5	31.0	32.0	33.0	34.0
	+10	19.5	20.5	22.0	23.0	24.0	25.0	26.0	27.0	28.0	29.5	30.5	31.5	32.5
	+15	19.0	20.0	21.0	22.0	23.0	24.0	25.0	26.0	27.0	28.0	29.0	30.0	31.0
	+20	18.0	19.0	20.0	21.0	22.0	23.0	24.0	25.0	26.0	27.0	28.0	29.0	30.0
	+25	17.0	18.0	19.0	20.0	21.0	22.0	23.0	24.0	25.0	26.0	27.0	27.5	29.0
	+30	16.5	17.0	18.0	19.0	20.0	21.0	22.0	23.0	24.0	25.0	25.5	26.5	27.5
	+35	16.0	16.5	17.5	18.0	19.0	20.0	21.0	22.0	23.0	24.0	24.5	25.5	26.5
	+40	15.0	15.5	16.5	17.5	18.5	19.5	20.0	21.0	22.0	23.0	23.5	24.5	25.5
	+45	14.0	15.0	15.5	16.5	17.5	18.5	19.0	20.0	21.0	22.0	22.5	23.5	24.5
	+50	13.5	14.5	15.0	16.0	17.0	18.0	18.5	19.5	20.5	21.0	22.0	22.5	23.5
+55	13.0	13.5	14.5	15.0	16.0	17.0	17.5	18.5	19.5	20.0	21.0	21.5	22.5	
+60	12.5	13.0	14.0	14.5	15.5	16.5	17.0	18.0	19.0	19.5	20.5	21.0	22.0	
real wood moisture in %														

9.4 General Concluding Remarks

The notes and tables in these operating instructions on permitted or normal humidity conditions in practice and the general definitions of terms have been taken from the specialist literature. No responsibility can therefore be taken by the manufacturer of the measuring device for the correctness of this information.

The conclusions to be drawn from the measurement results are related to the individual conditions and the knowledge from professional experience for each user. In cases of doubt, for example concerning the permitted moisture content in coating or screed substrates when laying floor coverings it is recommended to contact the manufacturer of the coating or floor covering and to take account of the recommendations of the trade associations/guilds.

Please note:

The instructions for use for the device and any accessories should be carefully observed, as supposed simplifications in handling often lead to measurement errors.

-Subject to technical changes-

Status: September 2024



GANN MESS- U. REGELTECHNIK GMBH

70839 GERLINGEN SCHILLERSTRASSE 63 INTERNET: <http://www.gann.de>

Verkauf National: TELEFON 071 56-4907-0 TELEFAX 071 56-4907-40 E-MAIL: verkauf@gann.de

Verkauf International: TELEFON +49-71 56-4907-0 TELEFAX +49-71 56-4907-48 E-MAIL: sales@gann.de

10 EU Declaration of Conformity



Document no. / order no.: 30011100

Product identifier: **HYDROMETTE BL H 40**

We declare that the hand-held meter and related accessory correspond with the protection requirements and if used according to their intended purpose, comply with the requirements of the directives:

2014/30/EU EMC Directive

2011/65/EU RoHS

Applied harmonized standards:

EN 61326-1 : 2013 General EMC requirements

EN IEC 63000 : 2018 Restriction of hazardous substances

This declaration is given in responsibility for:

Gann Mess- und Regeltechnik GmbH

Schillerstr. 63

70839 Gerlingen

Germany

issued by:

name: Michael Gann

Position in the company of manufacturer: Managing Director

Place / date: Gerlingen, 12 December 2024



(Legally valid signature)