

Quick Start Guide

Version 2.0



HYDROMETTE

BL COMPACT

TF-IR 2



EN



GANN MESS- U. REGELTECHNIK GMBH

70839 GERLINGEN

SCHILLERSTRASSE 63

INTERNET: <http://www.gann.de>

Verkauf National: TELEFON 07156-4907-0
Verkauf International: TELEFON +49 7156-4907-0

TELEFAX 07156-4907-40
TELEFAX +49 7156-4907-48

EMAIL verkauf@gann.de
EMAIL sales@gann.de

Disclaimer

GANN Mess- u. Regeltechnik GmbH does not make any assurances or warranties with respect to this document and, to the extent permitted by law, limits its liability for breach of any implied warranty to the replacement of this document with another. Furthermore, GANN Mess- u. Regeltechnik GmbH reserves the right to revise this publication at any time without having to notify anyone about such revisions.

The information provided in this documentation includes general descriptions and/or technical characteristics for the performance of the equipment described herein. This documentation cannot be used as a proper assessment of the suitability or reliability of the equipment for a specific application by a user and must not be used as a substitute for such an assessment. It is the responsibility of any such user to carry out an appropriate and complete risk assessment, evaluation and testing of the equipment with regard to his specific application. Neither GANN Mess- u. Regeltechnik GmbH nor any of its partner or subsidiary companies can be made responsible or liable in the event of misuse of the information contained in this document.

All relevant national, regional and local safety regulations must always be observed when installing and using this device. For reasons of safety and to ensure compliance with the documented system data, only the manufacturer is authorised to carry out repairs to components. Failure to observe this information may result in injury or damage to the equipment.

Copyright © 2024 GANN Mess- u. Regeltechnik GmbH, Gerlingen

All rights reserved. No part of this publication may be reproduced, processed or distributed in any form, including photocopying, recording or any other electronic or mechanical process, without the written permission of the publisher. Requests for permissions must be made in writing to the publisher at the address given on the title page.

Table of Contents

1	Foreword	4
1.1	Explanation of the General Warnings	5
1.2	Specific Warnings	5
2	Device Layout and Button Assignment	6
2.1	Display Symbols	7
2.2	Switching the Device On and Off	8
2.3	Setting Menus	9
2.3.1	Measuring Menu (Main Menu)	10
2.3.2	Measuring Mode Selection	11
3	Appendix	12
3.1	Measuring Mode Table	12

1 Foreword

This quick start guide contains an overview of the most important functions of the Hydromette BL Compact TF-IR 2. It only contains parts of the legal and safety-relevant information and has been abridged for better readability. A complete digital version of the operating instructions is available on our homepage in the download area (in **English**: pdf. file with **EN** extension):





<https://www.gann.de/en/products/handhelds/electronic-moisture-meters/blue-product-series/bl-compact-tf-ir-2#downloads>



Only use the device if you have read and understood all legal and safety-related information in the complete operating manual.

1.1 Explanation of the General Warnings

The following danger levels are used in this quick start guide to indicate potentially dangerous situations and important safety instructions:

Danger Level	Description
 DANGER	Danger / Indicates a hazardous situation which, if not avoided, will result in death or serious irreversible injuries.
 WARNING	Warning / Indicates a hazardous situation which, if not avoided, could result in death or serious irreversible injuries.
 CAUTION	Caution / Indicates a hazardous situation which, if not avoided, could result in minor or moderate injuries.
 INFORMATION	Indicates important information.

1.2 Specific Warnings

 CAUTION	The Hydromette BL Compact TF-IR 2 uses a laser in laser class 2 according to IEC 60825-1. People can be blinded by the laser. The laser must never be directed at people or animals. Do not look directly into the laser beam and avoid reflections on reflective surfaces.
---	---

2 Device Layout and Button Assignment



Figure 2-1: View of the Hydromette BL Compact TF-IR 2

2.1 Display Symbols

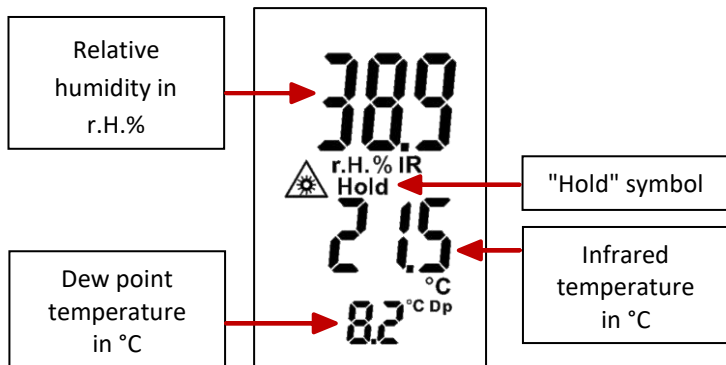

Figure 2-2: Main menu symbols

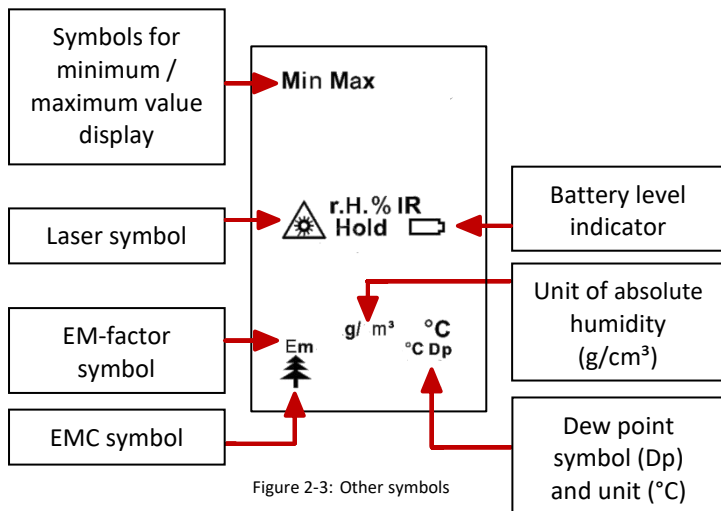

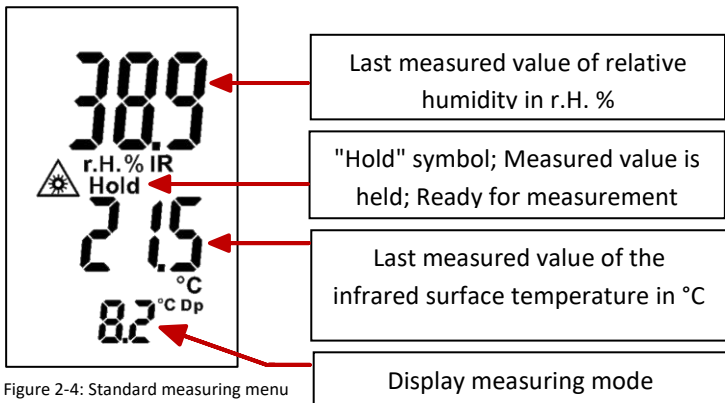

Figure 2-3: Other symbols

2.2 Switching the Device On and Off

The device is switched on and off by pressing the "On / Off" button . The device starts in the measuring menu or main menu. The measuring process can be carried out here (see [Chapter 2.3.1. "Measurement menu / main menu"](#)).



If the TF-stick is not (correctly) inserted, the display "InP SEa" is shown when the measuring button is pressed and held down for a long time (> 2 seconds)!

Figure 2-5: Error message, TF-Stick not detected

2.3 Setting Menus

The following menu items can be selected one after the other by repeatedly pressing the "**Down**" button.

1. **Measuring menu** (Main menu): The measuring process can be performed here.
2. **Measuring mode selection**: The different measuring modes can be set here.
3. **Laser-pointer- / EM-menu**: This menu can be used to disable/enable the laser pointer and to set the emissivity (EM factor).
4. **Maximum value display**: The largest measured value is shown here.
5. **Minimum value display**: The smallest measured value is shown here.
6. **Memory menu**: The last 5 measured values are stored here. The oldest value is overwritten after each measurement.

The menu items are selected in reverse order by pressing the "**Up**" button.

2.3.1 Measuring Menu (Main Menu)

After switching on, the device is in the measuring menu (main menu). The other menus can be accessed from here by pressing the "**Up**" or "**Down**" buttons.

In the measuring menu, the last measured values are displayed according to the measuring mode selection made with the associated units and the note "**Hold**".

A new measurement is started by pressing the "**M**" button (*> 2 seconds*).

During the measuring process, the "**Hold**" symbol disappears from the display. After releasing the "**M**" button, the measured value is held and automatically stored in the ring memory. This overwrites the oldest stored value. The "**Hold**" symbol is displayed again.

If the new measured value is larger than the previous maximum value, "**Max**" flashes on the display. If the new value should be accepted, the "**M**" button must be pressed *briefly (< 1 second)*. If the value should not be saved, a new measurement can be started by *pressing and holding (> 2 seconds)* the "**M**" button without changing the previous maximum value.

If the new measured value is smaller than the previous minimum value, "**Min**" flashes on the display. If the new value should be accepted, the "**M**" button must be pressed *briefly (< 1 second)*. If the value should not be saved, a new measurement can be started by *pressing and holding (> 2 seconds)* the "**M**" button without changing the previous minimum value.

2.3.2 Measuring Mode Selection

Die Hydromette BL Compact TF-IR 2 has 7 different setting modes ([see measuring mode table](#)). The selected mode changes the display of the measuring menu. Depending on the mode, the appropriate physical dimension is also displayed. The measuring mode selection is designed as a ring menu.

The device must be switched on and in the main measuring mode to be able to make the measuring mode settings. Press the "**Down**" button once to access the measuring mode selection. If the setting for the measuring mode should be changed now, the "**M**" button must be pressed *briefly (< 1 second)*.

The measuring mode display flashes and can be set using the "**Up**" and "**Down**" buttons. The change is saved by *briefly (< 1 second)* pressing the "**M**" button again.

After confirming the change, the display automatically jumps to the measuring menu of the (newly) selected measuring mode. This removes the values of the previous measuring mode from the display. Any stored "**Max**" or "**Min**" values remain in the memory of the respective measuring mode.

Now a new measurement can be performed by *pressing and holding (> 2 seconds)* the "**M**" button.

.

3 Appendix

3.1 Measuring Mode Table

Measuring mode	Measuring mode display
"Dew point IR"	(rh / ir / dp)
"Air temperature IR"	(rh / t / ir)
"Relative humidity"	(rh / t / rh)
"Air temperature"	(rh / t / t)
"Dew point Dp"	(rh / t / Dp)
"Equilibrium wood moisture content, EMC"	(rh / t / UGL)
"Absolute humidity"	(rh / Ah)

- Subject to technical changes-

Status: September 2024



GANN MESS- U. REGELTECHNIK GMBH

70839 GERLINGEN SCHILLERSTRASSE 63 INTERNET: <http://www.gann.de>

Verkauf National: TELEFON 071 56-49 07-0 TELEFAX 071 56-49 07-40 E-MAIL: verkauf@gann.de

Verkauf International: TELEFON +49-71 56-49 07-0 TELEFAX +49-71 56-49 07-48 E-MAIL: sales@gann.de